



# **DEEP SEA ELECTRONICS**

## **DSE335 MKII Operator Manual**

**Document Number: 057-368**

Author: Ian Roberts





**Deep Sea Electronics Ltd.**

Highfield House  
Hunmanby  
North Yorkshire  
YO14 0PH  
England

**Sales Tel:** +44 (0) 1723 890099

**E-mail:** [sales@deepseaelectronics.com](mailto:sales@deepseaelectronics.com)

**Website:** [www.deepseaelectronics.com](http://www.deepseaelectronics.com)

**DSE335 MKII Operator Manual**

© Deep Sea Electronics Ltd.

All rights reserved. No part of this publication may be reproduced in any material form (including photocopying or storing in any medium by electronic means or other) without the written permission of the copyright holder except in accordance with the provisions of the Copyright, Designs and Patents Act 1988.

Applications for the copyright holder's written permission to reproduce any part of this publication must be addressed to Deep Sea Electronics Ltd. at the address above.

The DSE logo and the names DSEGenSet®, DSEATS®, DSEPower® and DSEControl® are UK registered trademarks of Deep Sea Electronics Ltd.

Any reference to trademarked product names used within this publication is owned by their respective companies.

Deep Sea Electronics Ltd. reserves the right to change the contents of this document without prior notice.

**Amendments Since Last Publication**

Amd. No.	Comments	Date
1	Initial Release	01/08/2023

Typeface: The typeface used in this document is Arial. Care must be taken not to mistake the upper case letter I with the numeral 1. The numeral 1 has a top serif to avoid this confusion.

## TABLE OF CONTENTS

Section	Page
<b>1 INTRODUCTION.....</b>	<b>6</b>
1.1 CLARIFICATION OF NOTATION.....	7
1.2 GLOSSARY OF TERMS.....	7
1.3 BIBLIOGRAPHY.....	8
1.3.1 INSTALLATION INSTRUCTIONS.....	8
1.3.2 MANUALS.....	8
1.3.3 TRAINING GUIDES.....	9
1.3.4 THIRD PARTY DOCUMENTS.....	9
<b>2 SPECIFICATION.....</b>	<b>10</b>
2.1 OPERATING TEMPERATURE.....	10
2.2 REQUIREMENTS FOR UL.....	10
2.3 TERMINAL SPECIFICATION.....	11
2.4 POWER SUPPLY REQUIREMENTS.....	11
2.4.1 MODULE SUPPLY INSTRUMENTATION DISPLAY.....	11
2.5 S1 & S2 VOLTAGE / FREQUENCY SENSING.....	12
2.6 CURRENT SENSING.....	12
2.6.1 VA RATING OF THE CTS.....	13
2.6.2 CT POLARITY.....	14
2.6.3 CT PHASING.....	14
2.6.4 CT CLASS.....	14
2.7 INPUTS.....	15
2.7.1 DIGITAL INPUTS.....	15
2.8 CONFIGURABLE VOLT FREE RELAY OUTPUTS.....	16
2.8.1 CONFIGURABLE VOLT-FREE RELAY OUTPUTS A & E.....	16
2.8.2 CONFIGURABLE VOLT-FREE RELAY OUTPUTS B & F.....	16
2.8.3 CONFIGURABLE VOLT-FREE RELAY OUTPUTS C & D.....	16
2.8.4 CONFIGURABLE OUTPUTS G, H, I, J, K & L.....	16
2.9 COMMUNICATION PORTS.....	17
2.10 COMMUNICATION PORT USAGE.....	18
2.10.1 USB B PORT (PC CONFIGURATION).....	18
2.10.2 USB A PORT.....	18
2.10.3 RS485 PORT.....	19
2.10.3.1 CABLE SPECIFICATION.....	19
2.10.3.2 RECOMMENDED PC RS485 SERIAL PORT ADD-ONS.....	20
2.10.4 ETHERNET PORT.....	20
2.10.5 DSENET® (EXPANSION MODULES).....	21
2.11 SOUNDER.....	22
2.11.1 ADDING AN EXTERNAL SOUNDER.....	22
2.12 ACCUMULATED INSTRUMENTATION.....	22
2.13 DIMENSIONS AND MOUNTING.....	23
2.13.1 FIXING CLIPS.....	24
2.13.2 CABLE TIE FIXING POINTS.....	24
2.13.3 SILICON SEALING GASKET.....	25
2.13.3.1 FITTING THE GASKET.....	25
2.14 APPLICABLE STANDARDS.....	27
2.14.1 ENCLOSURE CLASSIFICATIONS.....	29
2.14.1.1 IP CLASSIFICATIONS.....	29
2.14.1.2 NEMA CLASSIFICATIONS.....	30
<b>3 INSTALLATION.....</b>	<b>31</b>
3.1 USER CONNECTIONS.....	31
3.2 CONNECTION DESCRIPTIONS.....	32
3.2.1 DC SUPPLY & OUTPUTS G TO L.....	32
3.2.2 CONFIGURABLE DIGITAL INPUTS A TO I.....	32
3.2.3 CONFIGURABLE DIGITAL INPUTS T TO L & DSENET®.....	33

3.2.4	CONFIGURABLE VOLT-FREE OUTPUTS E & F .....	33
3.2.5	LOAD SWITCHING AND S2 VOLTAGE SENSING.....	33
3.2.6	S1 VOLTAGE SENSING.....	34
3.2.7	CURRENT TRANSFORMERS.....	34
3.2.7.1	CT CONNECTIONS.....	35
3.2.8	CONFIGURABLE VOLT-FREE CHANGEOVER OUTPUTS C & D .....	36
3.2.9	RS485.....	36
3.2.10	USB B PORT (PC CONFIGURATION) CONNECTOR.....	37
3.2.11	USB A PORT CONNECTOR .....	37
3.2.12	ETHERNET .....	38
<b>3.3</b>	<b>TYPICAL SCHEMATIC DIAGRAM.....</b>	<b>39</b>
3.3.1	3 PHASE 4 WIRE.....	40
3.3.2	EARTH SYSTEMS.....	41
3.3.2.1	NEGATIVE EARTH.....	41
3.3.2.2	POSITIVE EARTH .....	41
3.3.2.3	FLOATING EARTH .....	41
<b>3.4</b>	<b>TYPICAL ARRANGEMENT OF DSENET® .....</b>	<b>42</b>
<b>3.5</b>	<b>ALTERNATIVE TOPOLOGY SCHEMATIC DIAGRAMS.....</b>	<b>43</b>
3.5.1	SINGLE PHASE 2 WIRE.....	43
3.5.2	2 PHASE (L1 & L2) 3 WIRE .....	44
3.5.3	2 PHASE (L1 & L3) 3 WIRE .....	45
3.5.4	3 PHASE 3 WIRE DELTA .....	46
3.5.5	3 PHASE 4 WIRE .....	47
<b>4</b>	<b>DESCRIPTION OF CONTROLS.....</b>	<b>48</b>
<b>4.1</b>	<b>CONTROL PUSH-BUTTONS .....</b>	<b>50</b>
<b>4.2</b>	<b>VIEWING THE INSTRUMENT PAGES.....</b>	<b>52</b>
4.2.1	STATUS .....	53
4.2.2	S1 .....	54
4.2.3	S2 .....	55
4.2.4	MODULE .....	56
4.2.5	EXPANSION.....	57
4.2.6	ALARMS.....	57
4.2.7	EVENT LOG .....	58
4.2.8	SCHEDULE .....	59
4.2.9	ABOUT .....	60
<b>4.3</b>	<b>VIEWING LATEST TRANSFER INFORMATION PAGE.....</b>	<b>60</b>
<b>4.4</b>	<b>USER CONFIGURABLE INDICATORS .....</b>	<b>61</b>
<b>5</b>	<b>OPERATION.....</b>	<b>62</b>
<b>5.1</b>	<b>QUICKSTART GUIDE.....</b>	<b>62</b>
5.1.1	STARTING S2.....	62
5.1.2	STOPPING S2.....	63
<b>5.2</b>	<b>START INHIBIT MODE.....</b>	<b>64</b>
<b>5.3</b>	<b>MANUAL MODE .....</b>	<b>64</b>
5.3.1	STARTING SEQUENCE .....	64
5.3.2	S2 AVAILABLE.....	65
5.3.3	STOPPING SEQUENCE.....	65
<b>5.4</b>	<b>AUTOMATIC MODE .....</b>	<b>66</b>
5.4.1	WAITING IN AUTO MODE.....	66
5.4.2	STARTING SEQUENCE .....	66
5.4.3	S2 AVAILABLE.....	67
5.4.4	STOPPING SEQUENCE.....	67
<b>5.5</b>	<b>MODE SELECTION .....</b>	<b>68</b>
5.5.1	TEST ON LOAD .....	68
5.5.1.1	STARTING SEQUENCE.....	68
5.5.1.2	S2 AVAILABLE .....	68
5.5.1.3	STOPPING SEQUENCE .....	68
5.5.2	TEST OFF LOAD .....	69
5.5.2.1	STARTING SEQUENCE.....	69
5.5.2.2	S2 AVAILABLE .....	69

5.5.2.3	STOPPING SEQUENCE .....	69
5.5.3	PROHIBIT RETURN .....	70
5.5.3.1	WAITING IN PROHIBIT RETURN .....	70
5.5.3.2	STARTING SEQUENCE .....	70
5.5.3.3	S2 AVAILABLE .....	71
5.5.3.4	STOPPING SEQUENCE .....	71
<b>5.6</b>	<b>SCHEDULER .....</b>	<b>72</b>
5.6.1	START INHIBIT MODE .....	72
5.6.2	MANUAL MODE .....	72
5.6.3	AUTO MODE .....	72
<b>5.7</b>	<b>CHANGEOVER FUNCTIONALITY .....</b>	<b>73</b>
5.7.1	OPEN TRANSITION WITHOUT CHECK SYNC .....	73
5.7.2	OPEN TRANSITION WITH CHECK SYNC .....	74
5.7.3	CLOSED TRANSITION WITH CHECK SYNC .....	75
5.7.4	MANUAL LOAD SHED INPUT .....	76
5.7.5	AUTOMATIC LOAD SHEDDING CONTROL .....	76
<b>6</b>	<b>PROTECTIONS .....</b>	<b>77</b>
6.1	ALARMS .....	77
6.2	INDICATIONS .....	78
6.3	WARNING ALARMS .....	79
6.4	ELECTRICAL TRIP ALARMS .....	81
<b>7</b>	<b>FRONT PANEL CONFIGURATION .....</b>	<b>83</b>
7.1	ACCESSING THE FRONT PANEL EDITOR .....	84
7.1.1	ENTERING PIN .....	84
7.1.2	EDITING A PARAMETER .....	85
7.1.3	EXITING THE MAIN CONFIGURATION EDITOR .....	85
7.1.4	MAIN CONFIGURATION EDITOR PARAMETERS .....	86
<b>8</b>	<b>COMMISSIONING .....</b>	<b>87</b>
<b>9</b>	<b>FAULT FINDING .....</b>	<b>88</b>
9.1	STARTING .....	88
9.2	LOADING .....	88
9.3	ALARMS .....	88
9.4	COMMUNICATIONS .....	88
9.5	INSTRUMENTS .....	89
9.6	MISCELLANEOUS .....	89
<b>10</b>	<b>MAINTENANCE, SPARES, REPAIR AND SERVICING .....</b>	<b>90</b>
10.1	PURCHASING ADDITIONAL CONNECTOR PLUGS FROM DSE .....	90
10.1.1	PACK OF PLUGS .....	90
10.1.2	INDIVIDUAL PLUGS .....	90
10.2	PURCHASING ADDITIONAL FIXING CLIPS FROM DSE .....	90
10.3	PURCHASING ADDITIONAL SEALING GASKET FROM DSE .....	90
10.4	DSENET EXPANSION MODULES .....	91
<b>11</b>	<b>WARRANTY .....</b>	<b>92</b>
<b>12</b>	<b>DISPOSAL .....</b>	<b>92</b>
12.1	WEEE (WASTE ELECTRICAL AND ELECTRONIC EQUIPMENT) .....	92

## 1 INTRODUCTION

This document details the installation and operation requirements of the DSE335 MKII module, part of the DSEATS® range of products.

It is essential to keep this manual for the entire lifespan of the product. If the product is passed on or supplied to another party, please ensure that this document is included for their reference.

This document is not considered a controlled document. Please note that updates to this document are not automatically communicated. Any future updates to this document can be found on the DSE website at [www.deepseaelectronics.com](http://www.deepseaelectronics.com).

The module has been designed to offer different levels of functionality on a shared platform. This allows the original equipment manufacturer (OEM) to have greater flexibility in selecting the appropriate controller for a specific application.

The module has been designed to allow the operator to control the transfer of the load from Source 1 (S1) to Source 2 (S2), typically the mains supply and a standby generator either manually (via fascia mounted pushbuttons) or automatically upon S1 failure. Additionally, if configured, the module can automatically start and stop the generator set (S2) based on the status of S1.

The user also has the ability to monitor the system's operating parameters and view them on the LCD display. This allows for the observation of power supplies and indicates the operational status and any fault conditions of the module.

The powerful ARM microprocessor contained within the module allows for incorporation of a range of complex features:

- *Text based LCD display*
- *True RMS Voltage*
- *Current and Power monitoring*
- *USB and RS485 Communications*
- *Fully configurable inputs for use as alarms or a range of different functions.*
- *Open and closed transition with Check sync option.*
- *Integral PLC to help provide customisation where required*
- *Data Logging*



The DSE Configuration Suite PC Software allows alteration of selected operational sequences, timers, alarms, and operational sequences. Additionally, the module's integral front panel configuration editor allows adjustment of this information.

Access to critical operational sequences and timers for use by qualified engineers, can be protected by a security code. Module access can also be protected by PIN code. Selected parameters can be changed from the module's front panel.

The module is housed in a robust plastic case suitable for panel mounting. Connections to the module are via locking plug and sockets.

## 1.1 CLARIFICATION OF NOTATION

Clarification of notation used within this publication.

 <b>NOTE:</b>	Highlights an essential element of a procedure to ensure correctness.
 <b>CAUTION!</b>	Indicates a procedure or practice, which, if not strictly observed, could result in damage or destruction of equipment.
 <b>WARNING!</b>	Indicates a procedure or practice, which could result in injury to personnel or loss of life if not followed correctly.

## 1.2 GLOSSARY OF TERMS

Term	Description
DSE335 MKII	DSE335 MKII module/controller
ATS	Automatic Transfer Switch. An Automatic Transfer Switch is a type of transfer panel used with a diesel generator to automatically switch between the mains and generator in the event of a power failure.
CAN	Controller Area Network. Vehicle standard to allow digital devices to communicate to one another.
HMI	Human Machine Interface. A device that provides a control and visualisation interface between a human and a process or machine.
LCD	Liquid Crystal Display. A flat-panel display or other electronically modulated optical device that uses the light-modulating properties of liquid crystals combined with polarizers.
LED	Light Emitting Diode. A semiconductor device that emits light when an electric current passes through it.
OEM	Original Equipment Manufacturer. A company that produces parts and equipment that may be used and marketed by another manufacturer.
PCI	Peripheral Component Interconnect. A local computer bus for attaching hardware devices in a computer and is part of the PCI Local Bus standard.
PIN	PIN number. A four digit number used to access the modules Main Front Panel Configuration Editor.
PLC	Programmable Logic Controller. A programmable digital device used to create logic for a specific purpose.
RTD	Resistance Temperature Detector. A sensor whose resistance changes as its temperature changes. The resistance increases as the temperature of the sensor increases.
SCADA	Supervisory Control And Data Acquisition. A system that operates with coded signals over communication channels to provide control and monitoring of remote equipment
TCP	Transmission Control Protocol. An industry standard that defines how to establish and maintain a network conversation via which application programs can exchange data.
USB	Universal Serial Bus. An industry standard that allows data exchange and delivery of power between many various types of electronics.

## 1.3 BIBLIOGRAPHY

This document refers to, and is referred by the following DSE publications which are obtained from the DSE website: [www.deepseaelectronics.com](http://www.deepseaelectronics.com) or by contacting DSE technical support: [support@deepseaelectronics.com](mailto:support@deepseaelectronics.com).

### 1.3.1 INSTALLATION INSTRUCTIONS

Installation instructions are supplied with the product in the box and are intended as a 'quick start' guide only.

DSE Part	Description
053-032	DSE2548 LED Expansion Annunciator Installation Instructions
053-033	DSE2130 Input Expansion Installation Instructions
053-034	DSE2157 Output Expansion Installation Instructions
053-272	DSE335 MKII Installation Instructions

### 1.3.2 MANUALS

Product manuals are obtained from the DSE website: [www.deepseaelectronics.com](http://www.deepseaelectronics.com) or by contacting DSE technical support: [support@deepseaelectronics.com](mailto:support@deepseaelectronics.com).

DSE Part	Description
N/A	DSEGencomm (MODBUS protocol for DSE controllers)
057-082	DSE2130 Input Expansion Operator Manual
057-083	DSE2157 Output Expansion Operator Manual
057-084	DSE2548 Annunciator Expansion Operator Manual
057-151	DSE Configuration Suite PC Software Installation & Operation Manual
057-175	PLC Programming Guide For DSE Controllers
057-220	Options for Communications with DSE Controllers
057-312	DSEAssistant PC Software Manual
057-314	Advanced PLC Programming Guide for DSE Controllers
057-367	DSE335 MKII Configuration Suite PC Software Manual



### 1.3.3 TRAINING GUIDES

Training guides are provided as 'hand-out' sheets on specific subjects during training sessions and contain specific information regarding to that subject.

DSE Part	Description
056-005	Using CTs With DSE Products
056-006	Introduction to Comms
056-022	Switchgear Control
056-026	kVA, kW, kvar and Power Factor
056-030	Module PIN Codes
056-036	DSE Module Expansion
056-043	Sync Process
056-051	Sending DSEGencomm Control Keys
056-069	Firmware Update
056-075	Adding Language Files
056-076	Reading DSEGencomm Alarms
056-079	Reading DSEGencomm Status
056-080	MODBUS
056-082	Override Gencomm PLC Example
056-091	Equipotential Earth Bonding
056-092	Best Practices for Wiring Restive Sensors
056-095	Remote Start Input Functions
056-097	USB Earth Loops and Isolation
056-099	Digital Output to Digital Input Connection

### 1.3.4 THIRD PARTY DOCUMENTS

The following third party documents are also referred to:

Reference	Description
ISBN 1-55937-879-4	IEEE Std C37.2-1996 IEEE Standard Electrical Power System Device Function Numbers and Contact Designations. Institute of Electrical and Electronics Engineers Inc
ISBN 0-7506-1147-2	Diesel Generator Handbook. L.L.J.Mahon
ISBN 0-9625949-3-8	On-Site Power Generation. EGSA Education Committee.

## 2 SPECIFICATION

### 2.1 OPERATING TEMPERATURE

Module	Specification
Operating Temperature	-22 °F to +158 °F (-30 °C to +70 °C)
Storage Temperature	-40 °F to +185 °F (-40 °C to +85 °C)

### 2.2 REQUIREMENTS FOR UL

Description	Specification
Screw Terminal Tightening Torque	<ul style="list-style-type: none"> <li>4.5 lb-in (0.5 Nm)</li> </ul>
Conductors	<ul style="list-style-type: none"> <li>Terminals suitable for connection of conductor size 12 AWG to 26 AWG (0.5 mm<sup>2</sup> to 2.0 mm<sup>2</sup>).</li> <li>Conductor protection must be provided in accordance with NFPA 70, Article 240</li> <li>Low voltage circuits (35 V or less) must be supplied from the engine starting battery or an isolated secondary circuit.</li> <li>The communication, sensor, and/or battery derived circuit conductors shall be separated and secured to maintain at least ¼ " (6 mm) separation from the generator and mains connected circuit conductors unless all conductors are rated 600 V or greater.</li> </ul>
Current Inputs	<ul style="list-style-type: none"> <li>Must be connected through UL Listed or Recognized isolating current transformers with the secondary rating of 5 A maximum.</li> </ul>
Communication Circuits	<ul style="list-style-type: none"> <li>Must be connected to communication circuits of UL Listed equipment</li> </ul>
Mounting	<ul style="list-style-type: none"> <li>Suitable for use in type 1 Enclosure Type rating with surrounding air temperature -22 °F to +122 °F (-30 °C to +50 °C)</li> <li>Suitable for pollution degree 3 environments when voltage sensing inputs do not exceed 300 V. When used to monitor voltages over 300 V, a device is to be installed in an unventilated or filtered ventilation enclosure to maintain a pollution degree 2 environment.</li> </ul>
Maximum Operating Temperature	<ul style="list-style-type: none"> <li>158 °F (70 °C)</li> </ul>
VTs	<ul style="list-style-type: none"> <li>When using voltage transformers (VTs) they must be fitted to both S1 and S2 voltage sensing, have the same ratio from the primary to secondary windings, and a 0° phase offset between the primary and secondary windings.</li> </ul>

## 2.3 TERMINAL SPECIFICATION

**NOTE:** For purchasing additional connector plugs from DSE, refer to the section entitled *Maintenance, Spares, Repair And Servicing* elsewhere in this document.

Description	Specification	
Connection Type	Two-part connector. Male part fitted to module Female part supplied in module packing case - Screw terminal, rising clamp, no internal spring.	 Example showing cable entry and screw terminals of a 10-way connector
Minimum Cable Size	0.5 mm <sup>2</sup> (AWG 20)	
Maximum Cable Size	2.5 mm <sup>2</sup> (AWG 13)	
Tightening Torque	0.5 Nm (4.5 lb-in)	
Wire Strip Length	7 mm (9/32 ")	

## 2.4 POWER SUPPLY REQUIREMENTS

Description	Specification
Minimum Supply Voltage	8 V continuous
Cranking Dropouts	Able to survive 0 V for 50 ms providing the supply was at least 10 V before the dropout and recovers to 5V afterwards.
Maximum Supply Voltage	35 V continuous (60 V protection)
Reverse Polarity Protection	-35 V continuous
Maximum Operating Current	216 mA at 24 V 396 mA at 12 V

### 2.4.1 MODULE SUPPLY INSTRUMENTATION DISPLAY

Description	Specification
Range	0 V to 70 V DC Maximum continuous operating voltage of 35 V DC
Resolution	0.1 V
Accuracy	1% full scale ( $\pm 0.7$ V)

## 2.5 S1 & S2 VOLTAGE / FREQUENCY SENSING

**NOTE:** When using voltage transformers (VTs) they must be fitted to both S1 and S2 sensing, have the same ratio from the primary to secondary windings, and a 0° phase offset between the primary and secondary windings.

Description	Specification
Measurement Type	True RMS conversion
Sample Rate	10 kHz
Harmonics	Up to 21 <sup>st</sup> or better
Input Impedance	300 k $\Omega$ ph-N
Phase To Neutral	15 V (minimum required for sensing frequency) to 415 V AC (absolute maximum) Suitable for 345 V AC nominal ( $\pm 20$ % for under/overvoltage detection)
Phase To Phase	25 V (minimum required for sensing frequency) to 720 V AC (absolute maximum) Suitable for 600 V AC nominal ( $\pm 20$ % for under/overvoltage detection)
Common Mode Offset From Earth	100 V AC (max)
Resolution	1V AC phase to neutral 2V AC phase to phase
Accuracy	$\pm 1$ % of full scale phase to neutral $\pm 2$ % of full scale phase to phase
Minimum Frequency	3.5 Hz
Maximum Frequency	75.0 Hz
Frequency Resolution	0.1 Hz
Frequency Accuracy	$\pm 0.2$ Hz

## 2.6 CURRENT SENSING

Description	Specification
Measurement Type	True RMS conversion
Sample Rate	10 kHz
Harmonics	Up to 21 <sup>st</sup> or better
Nominal CT Secondary Rating	1 A or 5 A
Maximum Continuous Current	5 A
Overload Measurement	3 x Nominal Range setting
Absolute Maximum Overload	50 A for 0.2 second 40 A for 1 second
Burden	0.5 VA (0.02 $\Omega$ current shunts)
Common Mode Offset	$\pm 2$ V peak plant ground to CT common terminal
Resolution	25 mA
Accuracy	$\pm 1$ % of Nominal (5 A) excluding CT error

### 2.6.1 VA RATING OF THE CTS

**NOTE:** Details for 4 mm<sup>2</sup> cables are shown for reference only. The connectors on the DSE modules are only suitable for cables up to 2.5 mm<sup>2</sup>.

The VA burden of the module on the CTs is 0.5 VA. However, depending upon the type and length of cabling between the CTs and the module, CTs with a greater VA rating than the module are required.

The distance between the CTs and the measuring module should be estimated and cross-referenced against the chart opposite to find the VA burden of the cable itself.

If the CTs are fitted within the alternator top box, the star point (common) of the CTs should be connected to system ground (earth) as close as possible to the CTs. This minimises the length of cable used to connect the CTs to the DSE module.

**Example:**

If 1.5 mm<sup>2</sup> cable is used and the distance from the CT to the measuring module is 20 m, then the burden of the cable alone is approximately 15 VA. As the burden of the DSE controller is .5 VA, then a CT with a rating of at least 15 VA + 0.5 VA = 15.5 VA must

be used. If 2.5 mm<sup>2</sup> cables are used over the same distance of 20 m, then the burden of the cable on the CT is approximately 7 VA. CT's required in this instance is at least 7.5 VA (7 + 0.5).

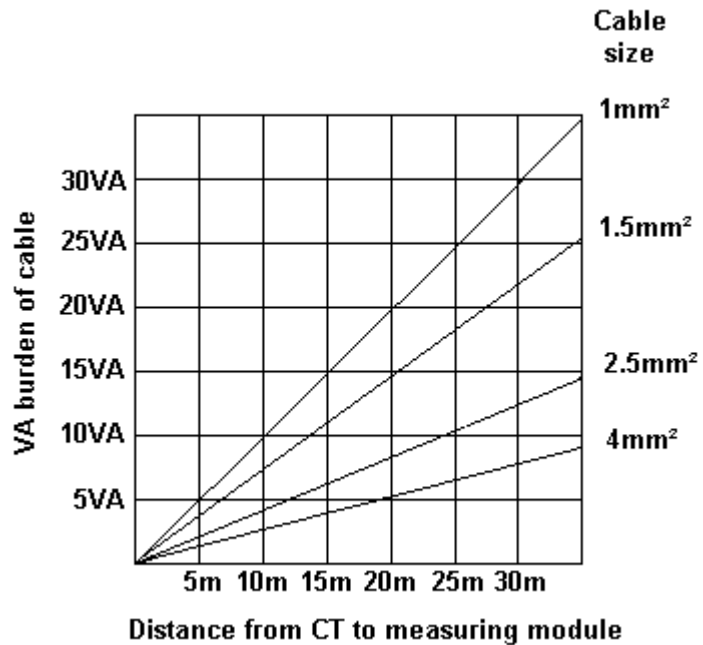

## 2.6.2 CT POLARITY

**NOTE:** Take care to ensure correct polarity of the CT primary as shown above. If in doubt, check with the CT supplier.

Take care to ensure the correct polarity of the CTs. Incorrect CT orientation leads to negative kW readings when the set is supplying power. Take note that paper stick-on labels on CTs that show the orientation are often incorrectly placed on the CT (!). It is more reliable to use the labelling in the case moulding as an indicator to orientation (if available).

To assess orientation, it is recommended to activate the source in island mode (if generator is applicable) and gradually load the source to approximately 10% of the specified rating. It is important to verify that the DSE module displays positive kilowatt (kW) readings for each of the three individual phases.

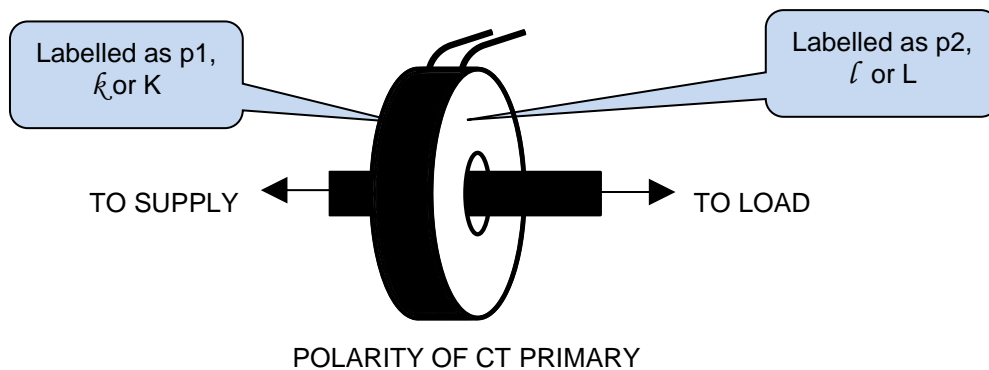

## 2.6.3 CT PHASING

Take particular care that the CTs are connected to the correct phases. For instance, ensure that the CT on phase 1 is connected to the terminal on the DSE module intended for connection to the CT for phase 1.

Additionally ensure that the voltage sensing for phase 1 is actually connected to generator phase 1. Incorrect connection of the phases as described above results in incorrect power factor (PF) measurements, which in turn results in incorrect kW measurements.

One way to check for this is to make use of a single-phase load. Place the load on each phase in turn, run the generator and ensure the kW value appears in the correct phase. For instance if the load is connected to phase 3, ensure the kW figure appears in phase 3 display and not in the display for phase 1 or 2.

## 2.6.4 CT CLASS

Ensure the correct CT type is chosen. For instance if the DSE module is providing overcurrent protection, ensure the CT is capable of measuring the overload level required to be protected against, and at the accuracy level required.

For instance, this may mean fitting a protection class CT (P10 type) to maintain high accuracy while the CT is measuring overload currents.

Alternatively, if the DSE module is solely utilizing the CT for instrumentation purposes, such as when the current protection feature is deactivated or the controller is not equipped with it, measurement class CTs are suitable for implementation. Again, bear in mind the accuracy required. The DSE module is accurate to better than 1% of the full-scale current reading. To maintain this accuracy fit Class 0.5 or Class 1 CTs.

Check with the CT manufacturer for further advice on selecting the CTs.

## 2.7 INPUTS

### 2.7.1 DIGITAL INPUTS

Description	Specification
Number	12 Configurable negative or positive switching inputs in banks of 3 through PC Software
Arrangement	Contact between input terminal and the module's plant supply negative or positive terminal.

#### Negative Switching Configuration

Description	Specification
Arrangement	Contact between input terminal and module supply negative
Closed Voltage Threshold	Less than 3.2 V
Open Voltage Threshold	Greater than 8.1 V
Maximum Input Voltage	+60 V DC with respect to module negative terminal
Minimum Input Voltage	-2 V DC with respect to module negative terminal.
Contact Wetting Current	6 mA $\pm$ 1 mA
Open Circuit Voltage	12 V $\pm$ 1 V

#### Positive Switching Configuration

Description	Specification
Arrangement	Contact between input terminal and module supply positive
Closed Voltage Threshold	Greater than 8.1 V
Open Voltage Threshold	Less than 3.2 V
Maximum Input Voltage	+60 V DC with respect to module negative terminal
Minimum Input Voltage	-2 V DC with respect to module negative terminal.
Contact Wetting Current	6 mA $\pm$ 1 mA
Open Circuit Voltage	0 V $\pm$ 1 V

## 2.8 CONFIGURABLE VOLT FREE RELAY OUTPUTS

**NOTE:** For further details on configuring and controlling different types of load switching devices refer to DSE Publication: 056-022 *Switchgear Control*.

There are twelve outputs fitted to the controller.

### 2.8.1 CONFIGURABLE VOLT-FREE RELAY OUTPUTS A & E

Description	Specification
Number	2
Type	Fully configurable normally closed volt-free contacts.
DC Rating	5 A resistive at 30 V
AC Rating	8 A resistive at 250 V

### 2.8.2 CONFIGURABLE VOLT-FREE RELAY OUTPUTS B & F

Description	Specification
Number	2
Type	Fully configurable normally open volt-free contacts.
DC Rating	5 A resistive at 30 V
AC Rating	8 A resistive at 250 V

### 2.8.3 CONFIGURABLE OUTPUTS VOLT-FREE RELAY OUTPUTS C & D



Description	Specification
Number	2
Type	Fully configurable volt-free changeover contacts.
DC Rating	5 A resistive at 30 V
AC Rating	8 A resistive at 250 V

### 2.8.4 CONFIGURABLE OUTPUTS G, H, I, J, K & L

Description	Specification
Number	6
Type	Fully configurable, supplied from DC positive terminal 2
Rating	2 A resistive at plant supply



## 2.9 COMMUNICATION PORTS

Description	Specification
USB B Port	Type B USB 2.0 For connection to PC running DSE Configuration Suite Max distance 5m (16 feet)
USB A Port	<div style="border: 1px solid black; padding: 2px; margin-bottom: 2px;">  <b>NOTE: The USB A port is not currently supported.</b> </div> Type A USB 2.0.
RS485 Serial port	Isolated Data connection 2 wire + common Half Duplex Data direction control for Transmit (by s/w protocol) Max Baud Rate 115200 External termination required (120 Ω) Max common mode offset 70 V (on board protection transorb) Max distance 1.2 km (¾ mile)
Ethernet	<div style="border: 1px solid black; padding: 2px; margin-bottom: 2px;">  <b>NOTE: The Ethernet port is not currently supported.</b> </div> Auto detecting 10/100 Mbit Ethernet port.
DSENet® (Expansion Comms) Port	Non-isolated Data connection 2 wire + common Half Duplex Data direction control for Transmit (by s/w protocol) Baud Rate of 115 kbaud Internal termination fitted (120 Ω) Max common mode offset ±5 V Max distance 1.2 km (¾ mile)

## 2.10 COMMUNICATION PORT USAGE

### 2.10.1 USB B PORT (PC CONFIGURATION)

**NOTE:** DSE stock 2 m (6.5 feet) USB type A to type B cable, DSE Part Number: 016-125. Alternatively, they are purchased from any PC or IT store.

**NOTE:** The DC supply must be connected to the module for configuration by PC.

**NOTE:** For further details of module configuration, refer to DSE Publication: 057-367 *DSE335 MKII Configuration Suite PC Software Manual*.

The USB B port is provided to give a simple means of connection between a PC and the controller. Using the DSE Configuration Suite Software, the operator is then able to control the module, starting or stopping the generator, selecting operating modes, etc.

Additionally, the various operating parameters (such as output volts, oil pressure, etc.) of the remote generator are available to be viewed or changed.

To connect a module to a PC by USB, the following items are required:

DSE335 MKII Controller



DSE Configuration Suite PC Software  
(Available from [www.deepseaelectronics.com](http://www.deepseaelectronics.com)).



USB cable Type A to Type B.  
(This is the same cable as often used between a PC and a USB printer)



DSE is able to supply this cable if required:  
PC Configuration interface lead (USB type A – type B)  
DSE Part No 016-125

### 2.10.2 USB A PORT

**NOTE:** The USB A port is not currently supported but is accessible in a future software update.

### 2.10.3 RS485 PORT

**NOTE:** For a single module to PC connection and distances up to 5 m (16 feet) the USB connection method is more suitable and provides for a lower cost alternative to RS485 (which is more suited to longer distance connections).

The RS485 port on the controller supports the MODBUS RTU protocol and is for connection to a single MODBUS master device only.

The DSE MODBUS register table for the controller is available upon request from the DSE Technical Support Department.

RS485 is used for point-to-point cable connection of more than one device (maximum 32 devices) and allows for connection to PCs, PLCs, and Building Management Systems (to name just a few devices).

One advantage of the RS485 interface is the large distance specification (1.2 km when using Belden 9841 (or equivalent) cable. This allows for a large distance between the module and a PC running the DSE Configuration Suite software. The operator is then able to control the module, starting or stopping the engine, selecting operating modes, etc.

The various operating parameters (such as coolant temperature, oil pressure, etc.) of the remote engine are viewed or changed.

Many PCs are not fitted with an internal RS485 serial port. DSE DOES NOT recommend the use of USB to RS485 convertors but is able to recommend PC add-ons to provide the computer with an RS485 port.

#### 2.10.3.1 CABLE SPECIFICATION

**NOTE:** DSE recommend Belden 9841 (or equivalent) cable for RS485 communication. This is rated to a maximum cable length of 1.2 km. DSE Stock Belden 9841 cable, DSE Part Number: 016-030.

Description	Specification
Cable Type	Two core screened and shielded twisted pair
Cable Characteristics	120 $\Omega$ impedance Low capacitance
Recommended Cable	Belden 9841 Belden 9271
Maximum Cable Length	1.2 km (¾ mile) when using Belden 9841 or direct equivalent. 600 m (656 yards) when using Belden 9271 or direct equivalent.
RS485 Topology	“Daisy Chain” Bus with no stubs (spurs)
RS485 Termination	120 $\Omega$ . Not fitted internally to module. Must be fitted externally to the ‘first’ and ‘last’ device on the RS485 link.

### 2.10.3.2 RECOMMENDED PC RS485 SERIAL PORT ADD-ONS

**NOTE:** DSE have no business tie to Brainboxes. Over many years, our own engineers have used these products and are happy to recommend them.

**NOTE:** For further details of setting up the devices below, refer to the manufacture whose details are below.

Remember to check these parts are suitable for your PC. Consult your PC supplier for further advice.

Brainboxes PM154 PCMCIA RS485 card (for laptops PCs)  
Set to 'Half Duplex, Autogating" with 'CTS True' set to 'enabled'

Brainboxes UC320 PCI Velocity RS485 card (for desktop PCs)  
Set to 'Half Duplex, Autogating" with 'CTS True' set to 'enabled'

Brainboxes PX-324 PCI Express 1 Port RS422/485 (for desktop PCs)

Supplier:  
Brainboxes  
Tel: +44 (0)151 220 2500  
Web: <http://www.brainboxes.com>  
Email: [sales@brainboxes.com](mailto:sales@brainboxes.com)



### 2.10.4 ETHERNET PORT

**NOTE:** The Ethernet port is not currently supported but is accessible in a future software update.

### 2.10.5 DSENET® (EXPANSION MODULES)

**▲ NOTE:** For further details of module configuration, refer to DSE Publication: 057-367 DSE335 MKII Configuration Suite PC Software Manual.

**▲ NOTE:** As a termination resistor is internally fitted to the controller, the controller must be the 'first' unit on the DSENet® link. A termination resistor **MUST** be fitted to the 'last' unit on the DSENet® link. For connection details, refer to section entitled *Typical Arrangement of DSENet*.

**▲ NOTE:** DSE recommend Belden 9841 (or equivalent) cable for DSENet® communication. This is rated to a maximum cable length of 1.2 km. DSE Stock Belden 9841 cable, DSE Part Number: 016-030.

DSENet® is the interconnection cable between the host controller and the expansion module(s) and must not be connected to any device other than DSE equipment designed for connection to the DSENet®

Description	Specification
Cable Type	Two core screened and shielded twisted pair
Cable Characteristics	120 Ω impedance Low capacitance
Recommended Cable	Belden 9841 Belden 9271
Maximum Cable Length	1200 m (¾ mile) when using Belden 9841 or direct equivalent. 600 m (656 yards) when using Belden 9271 or direct equivalent.
DSENet® Topology	"Daisy Chain" Bus with no stubs (spurs)
DSENet® Termination	120 Ω. Fitted internally to host controller. Must be fitted externally to the 'last' expansion module.
Maximum Expansion Modules	Total 6 devices made up of DSE2130 (up to 2), DSE2157 (up to 2), DSE2548 (up to 2).  This gives the possibility of: <ul style="list-style-type: none"> <li>• Maximum 16 additional relay outputs (DSE2157)</li> <li>• Maximum 16 additional LED indicators (DSE2548)</li> <li>• Maximum 16 additional inputs (Are configured as either digital, or resistive when using DSE2130).</li> </ul>

## 2.11 SOUNDER

**NOTE:** The unit does not come with an internal sounder, therefore an external sounder or indicator must be installed if an audible indication is necessary.

### 2.11.1 ADDING AN EXTERNAL SOUNDER

Should an external alarm or indicator be required, this is achieved by using the DSE Configuration Suite PC software to configure an auxiliary output for *Audible Alarm*, and by configuring an auxiliary input for *Alarm Mute* (if required).

The audible alarm output activates and de-activates at the same time as the module's internal sounder. The Alarm mute input and internal **Lamp Test / Alarm Mute** button activate 'in parallel' with each other. Either signal mutes both the internal sounder and audible alarm output.

Example of configuration to achieve external sounder with external alarm mute button:

The screenshot displays two configuration windows from the DSE Configuration Suite software. The top window, titled "Digital Outputs", shows a table of relay outputs (Output A through F) with their respective sources and polarities. The bottom window, titled "Digital Input A", shows the configuration for a specific digital input, including its function, polarity, action, arming, LCD display label, and activation delay.

Output	Source	Polarity
Output A (N/C)	Audible Alarm	Energise
Output B (N/O)	Close S2 Output	Energise
Output C (C/O)	Not Used	Energise
Output E (N/C)	S2 Start And Run	De-Energise
Output F (N/O)	Not Used	Energise

Function	Alarm Mute
Polarity	Close to Activate
Action	
Arming	
LCD Display	Digital Input A
Activation Delay	0s

## 2.12 ACCUMULATED INSTRUMENTATION

**NOTE:** When an accumulated instrumentation value exceeds the maximum number as listed below, the value is reset and begins counting from zero again.

Description	Specification
Accumulated Power	999999 kWh / kvarh / kVAh

## 2.13 DIMENSIONS AND MOUNTING

Parameter	Specification
Panel Cutout	220 mm x 160 mm (8.66 " x 6.30 ")
Overall Size	245.0 mm x 183.5 mm x 50.5 mm (9.65 " x 7.23 " x 1.99 ")
Case Material	Polycarbonate
Keypad Material	Silicone
Protection Category	IP65 panel mounted with gasket. IP42 panel mounted with no gasket.
Weight	0.70 kg (1.54 lb)
Mounting Type	Panel Mounting. Base mounted to a vertical surface with connection terminals to the rear.
Fixing Clip Torque	0.2 Nm

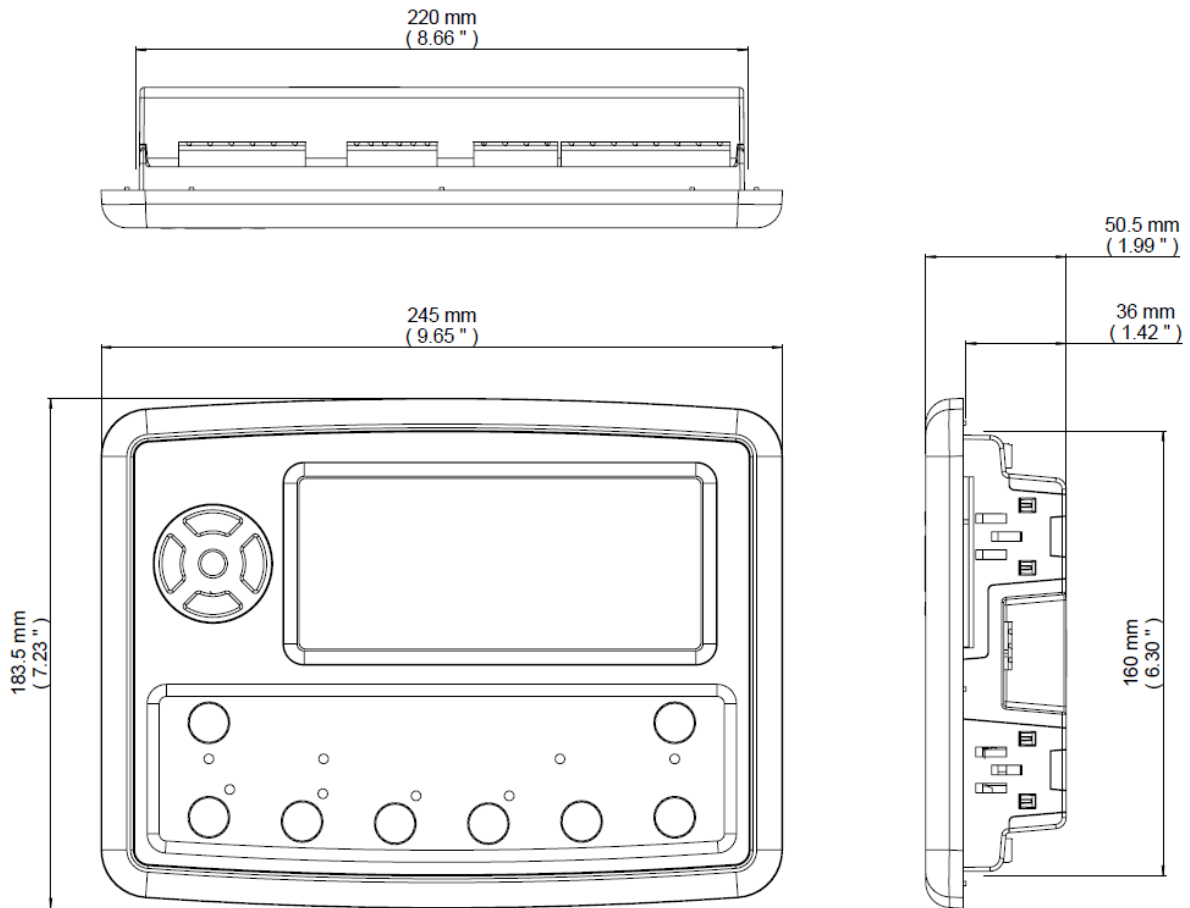

### 2.13.1 FIXING CLIPS

**NOTE:** In conditions of excessive vibration, mount the module on suitable anti-vibration mountings.

The module is held into the panel fascia using the supplied fixing clips.

- Withdraw the fixing clip screw (turn anticlockwise) until only the pointed end is protruding from the clip.
- Insert the three 'prongs' of the fixing clip into the slots in the side of the module case.
- Pull the fixing clip backwards (towards the back of the module) ensuring all three prongs of the clip are inside their allotted slots.
- Turn the fixing clip screws clockwise until they contact the panel fascia.
- Tighten the screws to a torque setting of 0.2 Nm to secure the module into the panel fascia. Care must be taken not to over tighten the fixing clip screws.

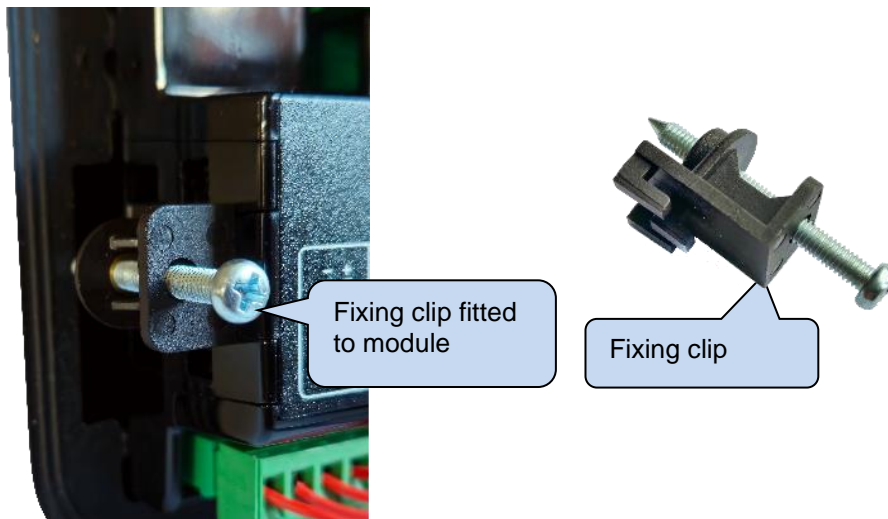

### 2.13.2 CABLE TIE FIXING POINTS

Integral cable tie fixing points are included on the rear of the module's case to aid wiring. This additionally provides strain relief to the cable loom by removing the weight of the loom from the screw connectors, thus reducing the chance of future connection failures.

Care is to be taken not to over tighten the cable tie (for instance with cable tie tools) to prevent the risk of damage to the module case.

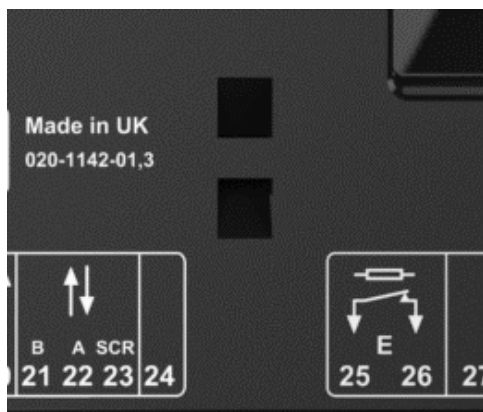

Cable tie fixing point

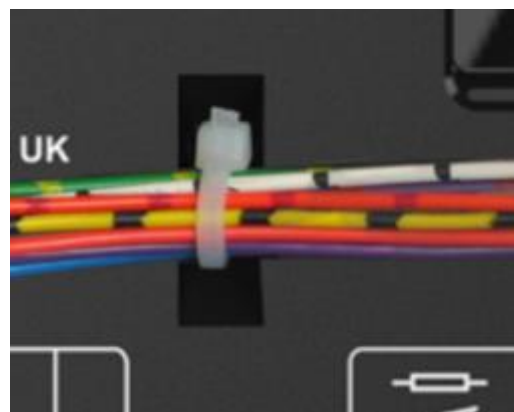

With cable and tie in place



### 2.13.3 SILICON SEALING GASKET

The supplied silicon gasket provides improved sealing between module and the panel fascia. The gasket is fitted to the module before installation into the panel fascia. The sealing gasket has locating holes for the locating pins on the plastic housing. Take care to ensure the gasket is correctly fitted to the module to maintain the integrity of the seal.



#### 2.13.3.1 FITTING THE GASKET

The gasket is secured in its position by locating pins and is installed in a single orientation.

- Locate the positioning pins on the rear of the module.

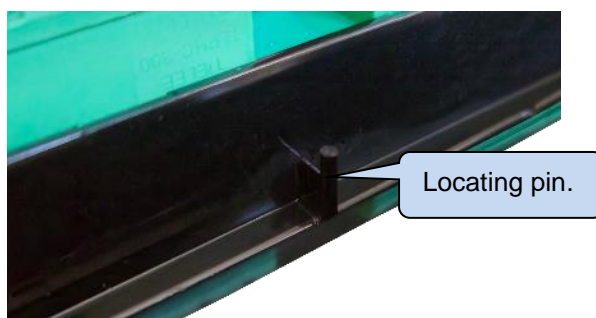

- Fit the gasket ensuring it sits flush to the back of the module.

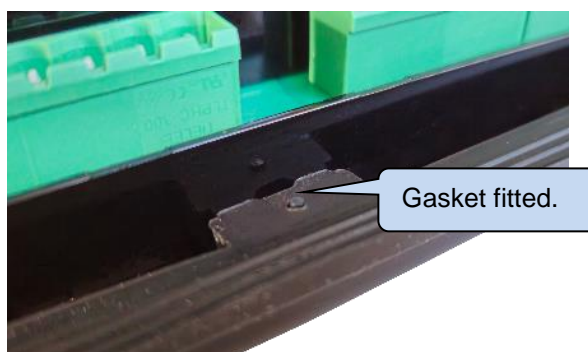

**Fitting Example**

- Poorly fitted gasket -The seal is trapped behind the module and does not provide ingress protection.



- Correctly fitted gasket -The gasket is flush to the panel and provides ingress protection.

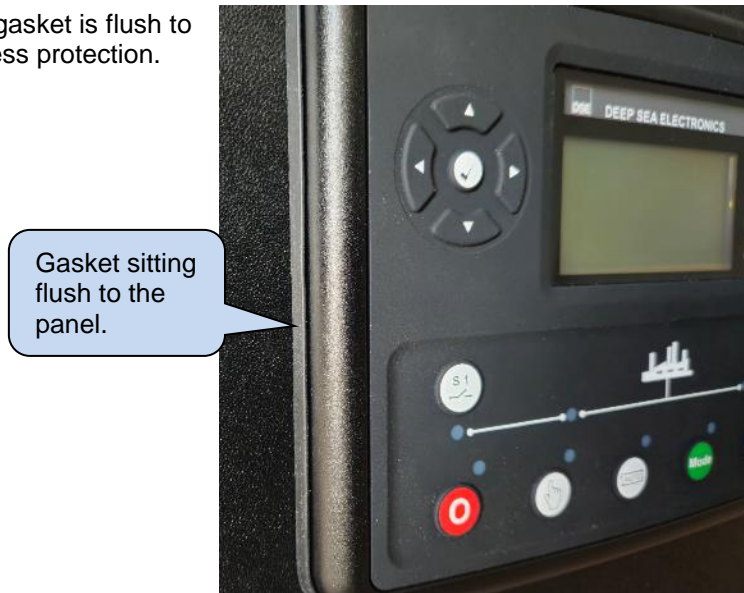

## 2.14 APPLICABLE STANDARDS

Standard	Description
<b>BS EN 60068-2-1</b> (Minimum temperature)	-30 °C (-22 °F)
<b>BS EN 60068-2-2</b> (Maximum temperature)	+70 °C (158 °F)
<b>BS EN 60068-2-6</b> (Vibration)	Ten sweeps in each of three major axes. 5 Hz to 8 Hz at +/-7.5 mm, 8 Hz to 500 Hz at 2 gn.
<b>BS EN 60068-2-27</b> (Shock)	Three shocks in each of three major axes 15 gn in 11 ms.
<b>BS EN 60068-2-30</b> (Humidity)	Db Damp Heat Cyclic 20/55° C at 95% RH 48 Hours.
<b>BS EN 60068-2-78</b> (Humidity)	Cab Damp Heat Static 40° C at 93% RH 48 Hours.
<b>BS EN 61010-1</b>	Safety requirements for electrical equipment for measurement, control, and laboratory use.
<b>BS EN 61000-6-2</b>	EMC Generic Immunity Standard (Industrial)
<b>BS EN 61000-6-4</b>	EMC Generic Emission Standard (Industrial)
<b>BS EN 60529</b> (Degrees of protection provided by enclosures)	IP65 (front of module when installed into the control panel with the optional sealing gasket) IP42 (front of module when installed into the control panel WITHOUT being sealed to the panel)
<b>UL508</b> <b>NEMA rating</b> (Approximate)	12 (Front of module when installed into the control panel with the supplied sealing gasket). 2 (Front of module when installed into the control panel WITHOUT being sealed to the panel)
<b>IEEE C37.2</b> (Standard Electrical Power System Device Function Numbers and Contact Designations)	<p>Under the scope of IEEE 37.2, <i>function numbers can also be used to represent functions in microprocessor devices and software programs.</i> The controller is device number 11L-8000 (Multifunction device protecting Line (generator) –module).</p> <p>As the module is configurable by the generator OEM, the functions covered by the module vary. Under the module's factory configuration, the device numbers included within the module are :</p> <ul style="list-style-type: none"> <li>2 – Time Delay Starting Or Closing Relay</li> <li>3 – Checking Or Interlocking Relay</li> <li>8 – Control Power Disconnecting Device</li> <li>11 – Multifunction Device</li> <li>23 – Temperature control device (<b>USING EXPANSION MODULE</b>)</li> <li>26 – Apparatus thermal device (<b>USING EXPANSION MODULE</b>)</li> <li>27AC – AC Undervoltage Relay</li> <li>27DC – DC Undervoltage Relay</li> <li>29 – Isolating Contactor Or Switch</li> <li>30 – Annunciator Relay</li> <li>37 – Undercurrent Or Underpower Relay (<b>USING INTERNAL PLC EDITOR</b>)</li> <li>42 – Running Circuit Breaker</li> <li>44 – Unit sequence relay</li> <li>48 – Incomplete Sequence Relay</li> </ul>

Continued overleaf...

Specification

Standard	Description
<b>IEEE C37.2</b> (Standard Electrical Power System Device Function Numbers and Contact Designations)	Continued...  49 – Machine Or Transformer Thermal Relay ( <b>USING EXPANSION MODULE</b> ) 50 – Instantaneous Overcurrent Relay 52 – AC Circuit Breaker 55 – Power Factor Relay ( <b>USING INTERNAL PLC EDITOR</b> ) 59AC – AC Overvoltage Relay 59DC – DC Overvoltage Relay 62 – Time Delay Stopping Or Opening Relay 63 – Pressure Switch 71 – Level Switch 74 – Alarm Relay 78 – Phase-angle measuring relay 79 – Reclosing relay ( <b>USING INTERNAL PLC EDITOR</b> ) 81 – Frequency Relay 83 – Automatic Selective Control Or Transfer Relay 86 – Lockout Relay

In line with our policy of continual development, Deep Sea Electronics, reserve the right to change specification without notice.

## 2.14.1 ENCLOSURE CLASSIFICATIONS

### 2.14.1.1 IP CLASSIFICATIONS

The modules specification under **BS EN 60529** Degrees of protection provided by enclosures

**IP65** (Front of module when module is installed into the control panel with the optional sealing gasket).

**IP42** (front of module when module is installed into the control panel WITHOUT being sealed to the panel)

First Digit	Second Digit
Protection against contact and ingress of solid objects	Protection against ingress of water
0 No protection	0 No protection
1 Protected against ingress solid objects with a diameter of more than 50 mm. No protection against deliberate access, e.g., with a hand, but large surfaces of the body are prevented from approach.	1 Protection against dripping water falling vertically. No harmful effect must be produced (vertically falling drops).
2 Protected against penetration by solid objects with a diameter of more than 12 mm. Fingers or similar objects prevented from approach.	2 Protection against dripping water falling vertically. There must be no harmful effect when the equipment (enclosure) is tilted at an angle up to 15° from its normal position (drops falling at an angle).
3 Protected against ingress of solid objects with a diameter of more than 2.5 mm. Tools, wires etc. with a thickness of more than 2.5 mm are prevented from approach.	3 Protection against water falling at any angle up to 60° from the vertical. There must be no harmful effect (spray water).
4 Protected against ingress of solid objects with a diameter of more than 1 mm. Tools, wires etc. with a thickness of more than 1 mm are prevented from approach.	4 Protection against water splashed against the equipment (enclosure) from any direction. There must be no harmful effect (splashing water).
5 Protected against harmful dust deposits. Ingress of dust is not totally prevented but the dust must not enter in sufficient quantity to interface with satisfactory operation of the equipment. Complete protection against contact.	5 Protection against water projected from a nozzle against the equipment (enclosure) from any direction. There must be no harmful effect (water jet).
6 Protection against ingress of dust (dust tight). Complete protection against contact.	6 Protection against heavy seas or powerful water jets. Water must not enter the equipment (enclosure) in harmful quantities (splashing over).

2.14.1.2 NEMA CLASSIFICATIONS

 **NOTE: There is no direct equivalence between IP / NEMA ratings. IP figures shown are approximate only.**

**12** (Front of module when module is installed into the control panel with the optional sealing gasket).

**2** (Front of module when module is installed into the control panel WITHOUT being sealed to the panel)

1 <b>IP30</b>	Provides a degree of protection against contact with the enclosure equipment and against a limited amount of falling dirt.
2 <b>IP31</b>	Provides a degree of protection against limited amounts of falling water and dirt.
3 <b>IP64</b>	Provides a degree of protection against windblown dust, rain, and sleet; undamaged by the formation of ice on the enclosure.
3R <b>IP32</b>	Provides a degree of protection against rain and sleet;; undamaged by the formation of ice on the enclosure.
4 (X) <b>IP66</b>	Provides a degree of protection against splashing water, windblown dust and rain, hose directed water, undamaged by the formation of ice on the enclosure. (Resist corrosion).
12/12K <b>IP65</b>	Provides a degree of protection against dust, falling dirt and dripping non-corrosive liquids.
13 <b>IP65</b>	Provides a degree of protection against dust and spraying of water, oil, and non-corrosive coolants.

### 3 INSTALLATION

The module is designed to be mounted on the panel fascia. For dimension and mounting details, refer to the section entitled *Accumulated Instrumentation*

**▲ NOTE: When an accumulated instrumentation value exceeds the maximum number as listed below, the value is reset and begins counting from zero again.**

Description	Specification
Accumulated Power	999999 kWh / kvarh / kVAh

Dimensions and Mounting elsewhere in this document.

### 3.1 USER CONNECTIONS

**NOTE:** Availability of some terminals depends upon module version. The Ethernet and USB Host ports are currently unavailable with the current firmware release.

To aid user connection, icons are used on the rear of the module to help identify terminal functions. An example of this is shown below.

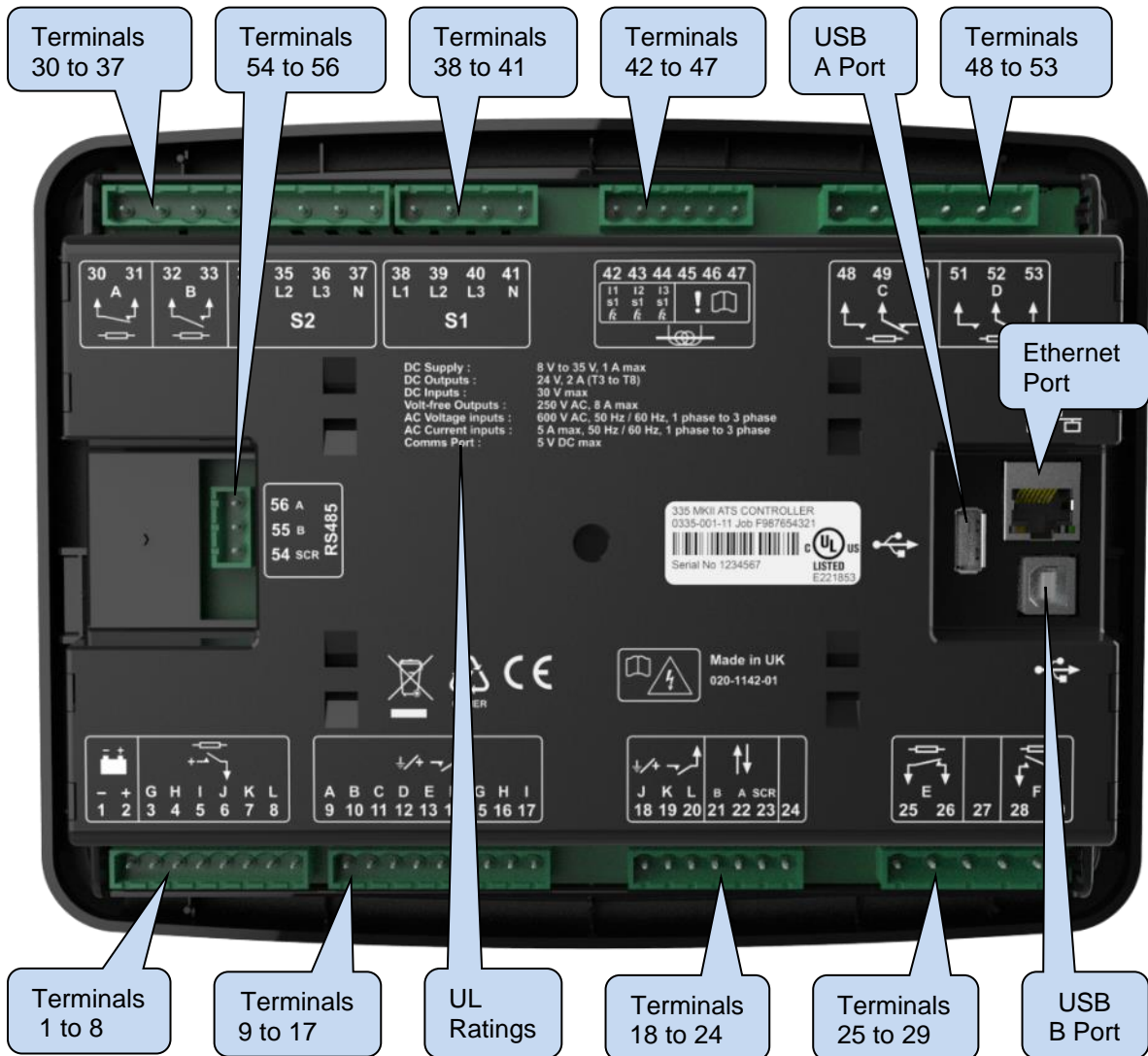





### 3.2 CONNECTION DESCRIPTIONS

#### 3.2.1 DC SUPPLY & OUTPUTS G TO L

 **NOTE: For further details of module configuration, refer to DSE Publication: 057-237 DSE335 Configuration Suite Software Manual.**



	Pin No	Description	Cable Size	Notes
	1	DC Plant Supply Input (Negative)	2.5 mm <sup>2</sup> AWG 13	Connect to ground where applicable.
	2	DC Plant Supply Input (Positive)	2.5 mm <sup>2</sup> AWG 13	Supplies the module and DC Outputs G, H, I, J, K & L
	3	DC Output G	1.0 mm <sup>2</sup> AWG 18	Plant Supply Positive from terminal 2. 2 Amp rated.
	4	DC Output H	1.0 mm <sup>2</sup> AWG 18	Plant Supply Positive from terminal 2. 2 Amp rated.
	5	DC Output I	1.0 mm <sup>2</sup> AWG 18	Plant Supply Positive from terminal 2. 2 Amp rated.
	6	DC Output J	1.0 mm <sup>2</sup> AWG 18	Plant Supply Positive from terminal 2. 2 Amp rated.
	7	DC Output K	1.0 mm <sup>2</sup> AWG 18	Plant Supply Positive from terminal 2. 2 Amp rated.
	8	DC Output L	1.0 mm <sup>2</sup> AWG 18	Plant Supply Positive from terminal 2. 2 Amp rated.

#### 3.2.2 CONFIGURABLE DIGITAL INPUTS A TO I

	Pin No	Description	Cable Size	Notes
	9	Configurable Digital Input A	0.5 mm <sup>2</sup> AWG 20	Switch to negative or positive depending on configuration
	10	Configurable Digital Input B	0.5 mm <sup>2</sup> AWG 20	Switch to negative or positive depending on configuration
	11	Configurable Digital Input C	0.5 mm <sup>2</sup> AWG 20	Switch to negative or positive depending on configuration
	12	Configurable Digital Input D	0.5 mm <sup>2</sup> AWG 20	Switch to negative or positive depending on configuration
	13	Configurable Digital Input E	0.5 mm <sup>2</sup> AWG 20	Switch to negative or positive depending on configuration
	14	Configurable Digital Input F	0.5 mm <sup>2</sup> AWG 20	Switch to negative or positive depending on configuration
	15	Configurable Digital Input G	0.5 mm <sup>2</sup> AWG 20	Switch to negative or positive depending on configuration
	16	Configurable Digital Input H	0.5 mm <sup>2</sup> AWG 20	Switch to negative or positive depending on configuration
	17	Configurable Digital Input I	0.5 mm <sup>2</sup> AWG 20	Switch to negative or positive depending on configuration



### 3.2.3 CONFIGURABLE DIGITAL INPUTS T TO L & DSENET®

 **NOTE: Terminal 24 is not used, do not connect.**

	Pin No	Description	Cable Size	Notes
	18	Configurable Digital Input J	0.5 mm <sup>2</sup> AWG 20	Switch to negative or positive depending on configuration
	19	Configurable Digital Input K	0.5 mm <sup>2</sup> AWG 20	Switch to negative or positive depending on configuration
	20	Configurable Digital Input L	0.5 mm <sup>2</sup> AWG 20	Switch to negative or positive depending on configuration
	21	DSENet® Expansion B	0.5 mm <sup>2</sup> AWG 20	Use only 120 Ω RS485 approved cable
	22	DSENet® Expansion A	0.5 mm <sup>2</sup> AWG 20	Use only 120 Ω RS485 approved cable
	23	DSENet® Expansion SCR	0.5 mm <sup>2</sup> AWG 20	Use only 120 Ω RS485 approved cable



### 3.2.4 CONFIGURABLE VOLT-FREE OUTPUTS E & F

 **NOTE: Terminal 27 is not used, do not connect.**

	Pin No.	Description	Cable Size	Notes
	25	Normally Closed Volt-Free Output Relay E	1.0 mm <sup>2</sup> AWG 18	Normally closed volt-free relay user configured (8 A resistive at 250 V AC rated)
	26		1.0 mm <sup>2</sup> AWG 18	Normally closed volt-free relay user configured (8 A resistive at 250 V AC rated)
	28	Normally Open Volt-Free Output Relay F	1.0 mm <sup>2</sup> AWG 18	Normally open volt-free relay user configured (8 A resistive at 250 V AC rated)
	29		1.0 mm <sup>2</sup> AWG 18	Normally open volt-free relay user configured (8 A resistive at 250 V AC rated)

### 3.2.5 LOAD SWITCHING AND S2 VOLTAGE SENSING

 **NOTE: The below table describes connections to a three phase, four wire S2 supply. For alternative wiring topologies, please see the ALTERNATIVE AC TOPOLOGIES section of this manual.**

	Pin No.	Description	Cable Size	Notes
	30	Normally Closed Output Relay A	1.0 mm <sup>2</sup> AWG 18	Normally configured to control S1 contactor coil (Recommend 10A fuse)
	31		1.0 mm <sup>2</sup> AWG 18	Normally configured to control S1 contactor coil
	32	Normally Open Output Relay B	1.0 mm <sup>2</sup> AWG 18	Normally configured to control S2 contactor coil (Recommend 10A fuse)
	33		1.0 mm <sup>2</sup> AWG 18	Normally configured to control S2 contactor coil
<b>S2</b>	34	S2 L1 Voltage Sensing Input	1.0 mm <sup>2</sup> AWG 18	Connect to S2 L1 (U) output (AC) (Recommend 2A fuse)
	35	S2 L2 Voltage Sensing Input	1.0 mm <sup>2</sup> AWG 18	Connect to S2 L2 (V) output (AC) (Recommend 2A fuse)
	36	S2 L3 Voltage Sensing Input	1.0 mm <sup>2</sup> AWG 18	Connect to S2 L3 (W) output (AC) (Recommend 2A fuse)
	37	S2 Neutral Input	1.0 mm <sup>2</sup> AWG 18	Connect to S2 Neutral terminal (AC)

### 3.2.6 S1 VOLTAGE SENSING

 **NOTE:** For details on alternative wiring configurations, see section entitled *Alternative Topology Schematic Diagrams* elsewhere in this document.

Pin No.	Description	Cable Size	Notes	
<b>S1</b>	38	S1 L1 Voltage Sensing Input	1.0 mm <sup>2</sup> AWG 18	Connect to S1 L1 (R) incoming supply (AC) (Recommend 2A fuse)
	39	S1 L2 Voltage Sensing Input	1.0 mm <sup>2</sup> AWG 18	Connect to S1 L1 (S) incoming supply (AC) (Recommend 2A fuse)
	40	S1 L3 Voltage Sensing Input	1.0 mm <sup>2</sup> AWG 18	Connect to S1 L1 (T) incoming supply (AC) (Recommend 2A fuse)
	41	S1 Neutral Input	1.0 mm <sup>2</sup> AWG 18	Connect to S1 N incoming supply (AC)

### 3.2.7 CURRENT TRANSFORMERS

 **WARNING!** Do not disconnect this plug when the CTs are carrying current. Disconnection does open circuit the secondary of the C.T.'s and dangerous voltages may then develop. Always ensure the CTs are not carrying current and the CTs are short circuit connected before making or breaking connections to the module.

 **NOTE:** The module has a burden of 0.5 VA on the CT. Ensure the CT is rated for the burden of the controller, the cable length being used and any other equipment sharing the CT. If in doubt, consult your CT supplier.

 **NOTE:** Take care to ensure correct polarity of the CT primary as shown below. If in doubt, consult with the CT supplier.

Pin No.	Description	Cable Size	Notes	
	42	CT Secondary for Load L1	2.5 mm <sup>2</sup> AWG 13	Connect to s1 secondary of L1 monitoring CT
	43	CT Secondary for Load L2	2.5 mm <sup>2</sup> AWG 13	Connect to s1 secondary of L2 monitoring CT
	44	CT Secondary for Load L3	2.5 mm <sup>2</sup> AWG 13	Connect to s1 secondary of L3 monitoring CT
	45	DO NOT CONNECT		DO NOT CONNECT
	46	CT Common	2.5 mm <sup>2</sup> AWG 13	Common for CTs
	47	DO NOT CONNECT		DO NOT CONNECT

### 3.2.7.1 CT CONNECTIONS

p1,  $\kappa$  or K is the primary of the CT that 'points' towards the SUPPLY

p2,  $\iota$  or L is the primary of the CT that 'points' towards the LOAD

s1 is the secondary of the CT that connects to the DSE Module's input for the CT measuring

s2 is the secondary of the CT that must be commoned with the s2 connections of all the other CTs and connected to the CT common terminal of the module.

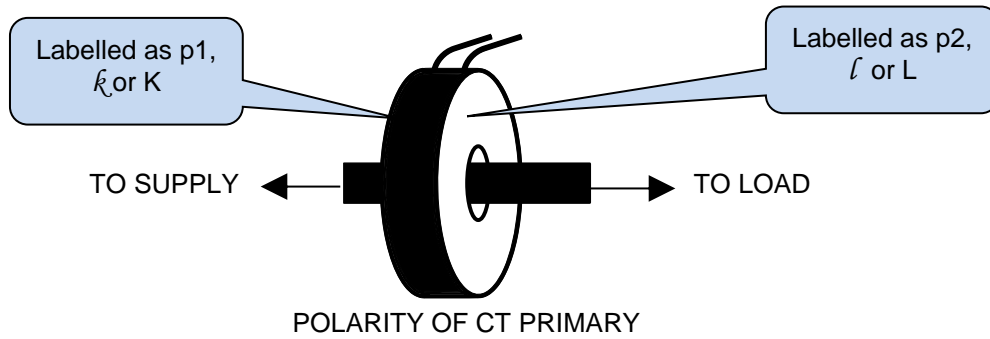

### 3.2.8 CONFIGURABLE VOLT-FREE CHANGEOVER OUTPUTS C & D

**NOTE:** For further details of module configuration, refer to *DSE Publication: 057-237 DSE335 MKII Configuration Suite Software Manual*.

Pin No.	Description	Cable Size	Notes
	48	Output C Normally Open	Volts free relay change-over relay user configured (8A resistive at 250V AC rated)
	49	Output C Common	
	50	Output C Normally Closed	
	51	Output D Normally Open	Volts free relay change-over relay user configured (8A resistive at 250V AC rated)
	52	Output D Common	
	53	Output D Normally Closed	

### 3.2.9 RS485

**NOTE:** For further details of module configuration, refer to *DSE Publication: 057-237 DSE335 MKII Configuration Suite PC Software Manual*.

**NOTE:** A 120 Ω termination resistor must be fitted across terminals A and B if the DSE module is the first or last device on the R485 link.

**NOTE:** Screened 120 Ω impedance cable specified for use with RS485 must be used for the RS485 link.  
DSE stock and supply Belden cable 9841 which is a high quality 120 Ω impedance cable suitable for CAN use (DSE part number 016-030)



Pin No.	Description	Cable Size	Notes
<b>RS485</b>	54	RS485 Port Screen	Shield Use only 120 Ω CAN or RS485 approved cable
	55	RS485 Port B (+)	0.5 mm <sup>2</sup> AWG 20 Connect to RXD+ and TXD+ Use only 120 Ω CAN or RS485 approved cable
	56	RS485 Port A (-)	0.5 mm <sup>2</sup> AWG 20 Connect to RXD+ and TXD+ Use only 120 Ω CAN or RS485 approved cable

### 3.2.10 USB B PORT (PC CONFIGURATION) CONNECTOR

**NOTE:** For further details of module configuration, refer to DSE Publication: 057-367 *DSE335 MKII Configuration Suite Software Manual*.

**NOTE:** The USB connection cable between the PC and the module must not be extended beyond 5m (16 feet). For distances over 6m, it is possible to use a third party USB extender. Typically, they extend USB up to 50m (55 yards). The supply and support of this type of equipment is outside the scope of Deep Sea Electronics PLC.

**CAUTION!** Care must be taken not to overload the PC's USB system by connecting more than the recommended number of USB devices to the PC. For further information, consult the PC supplier.

	Description	Cable Size	Notes
	Socket for connection to PC with DSE Configuration Suite Software	0.5 mm <sup>2</sup> AWG 20	This is a standard USB type A to type B connector. 

### 3.2.11 USB A PORT CONNECTOR

**NOTE:** The USB A port is not currently supported but is accessible in a future software update.



**NOTE:** For further details of module configuration, refer to DSE Publication: 057-367 *DSE335 MKII Configuration Suite PC Software Manual*.

	Description	Storage Size	Notes
	Socket for connection to USB.	N/A	

### 3.2.12 ETHERNET

 **NOTE:** The Ethernet port is not currently supported but is accessible in a future software update.

 **NOTE:** For further details of module configuration, refer to DSE Publication: *057-367 DSE335 MKII Configuration Suite PC Software Manual*.

	Description	Cable Size	Notes	
	Socket for connection to Ethernet used for point-to-point cable connection.	0.1 mm <sup>2</sup> AWG 26	This is a standard Ethernet cable	

### 3.3 TYPICAL SCHEMATIC DIAGRAM

As every system has different requirements, these diagrams show only a typical system and do not intend to show a complete system.

Genset manufacturers and panel builders may use these diagrams as a starting point; however always refer to the completed system diagram provided by the system manufacturer for complete wiring detail.

Further wiring suggestions are available in the following DSE publications, available at [www.deepseaelectronics.com](http://www.deepseaelectronics.com) to website members.

DSE Part	Description
056-022	Switchgear Control (Training guide)
056-005	Using CTs With DSE Products
056-091	Equipotential Earth Bonding



3.3.1 3 PHASE 4 WIRE

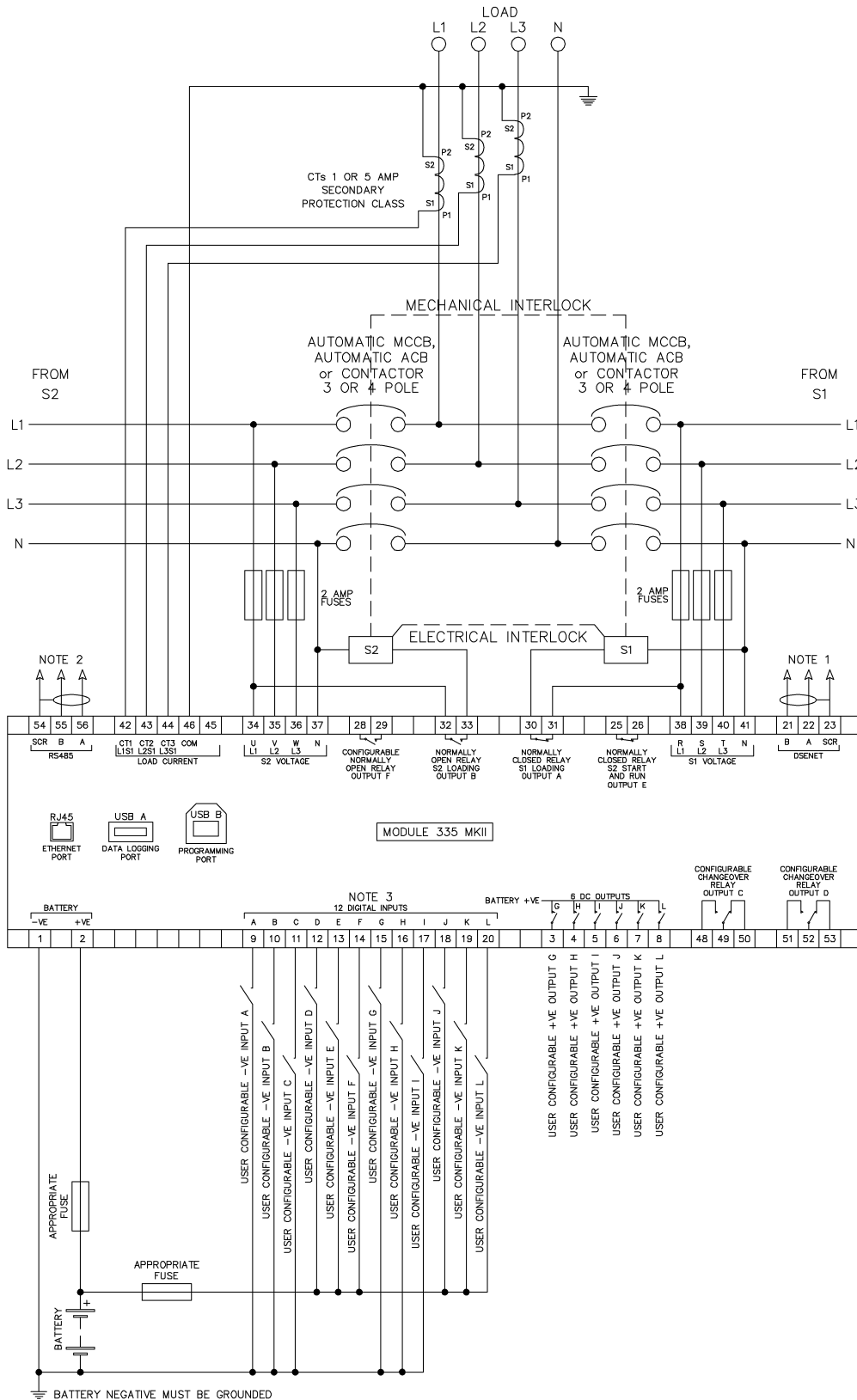

BATTERY NEGATIVE MUST BE GROUND

NOTE 1. MUST BE FITTED AS FIRST OR LAST UNIT ON THE DSENET LINK WITH NO EXTERNAL TERMINATION RESISTOR. THE SUBSEQUENT FIRST OR LAST UNIT ON DSENET MUST BE FITTED WITH A 120 OHM TERMINATION RESISTOR ACROSS TERMINALS A AND B.

NOTE 2. IF THE MODULE IS FIRST OR LAST UNIT ON THE LINK IT MUST BE FITTED WITH AN EXTERNAL 120 OHM TERMINATION RESISTOR ACROSS TERMINALS A AND B OR H AND L.

NOTE 3. DIGITAL INPUTS ARE CONFIGURABLE IN GROUPS OF THREE AS NEGATIVE OR POSITIVE SWITCHING.

### **3.3.2 EARTH SYSTEMS**

#### **3.3.2.1 NEGATIVE EARTH**

The typical wiring diagrams located within this document show connections for a negative earth system (the battery negative connects to Earth)

#### **3.3.2.2 POSITIVE EARTH**

When using a DSE module with a Positive Earth System (the battery positive connects to Earth), the following points must be followed:

Follow the typical wiring diagram as normal for all sections EXCEPT the earth points  
All points shown as Earth on the typical wiring diagram must connect to BATTERY NEGATIVE (not earth).

#### **3.3.2.3 FLOATING EARTH**

Where neither the battery positive nor battery negative terminals are connected to earth the following points must be followed

Follow the typical wiring diagram as normal for all sections EXCEPT the earth points  
All points shown as Earth on the typical wiring diagram must connect to BATTERY NEGATIVE (not earth).

### 3.4 TYPICAL ARRANGEMENT OF DSENET®

Six (6) devices can be connected to the DSENet®, made up of the following devices :

Device	Max Number Supported
DSE2130 Input Expansion	2
DSE2157 Relay Output Expansion	2
DSE2548 LED Expansion	2

For part numbers of the expansion modules and their documentation, see section 10.4 entitled *DSENet Expansion Modules*.

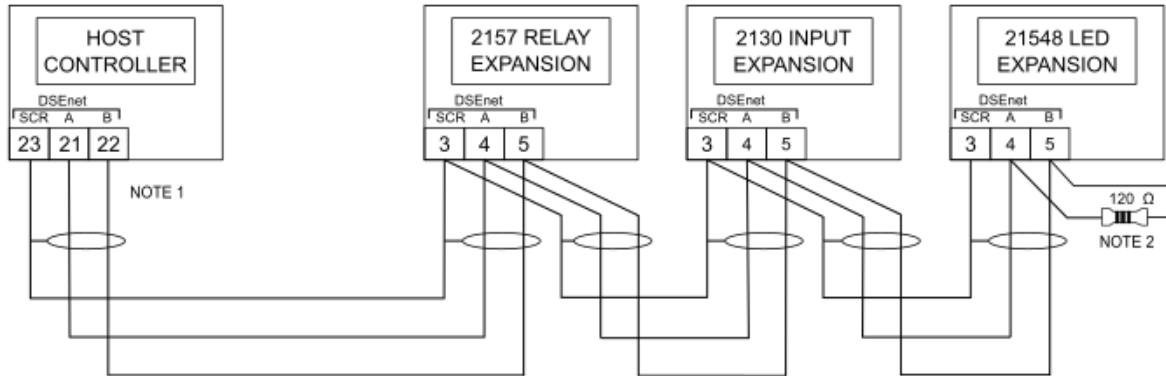

**NOTE 1**  
 AS A TERMINATING RESISTOR IS INTERNALLY FITTED TO THE HOST CONTROLLER, THE HOST CONTROLLER MUST BE THE FIRST UNIT ON THE DSEnet

**NOTE 2**  
 A 120 OHM TERMINATION RESISTOR MUST BE FITTED TO THE LAST UNIT ON THE DSEnet

### 3.5 ALTERNATIVE TOPOLOGY SCHEMATIC DIAGRAMS

#### 3.5.1 SINGLE PHASE 2 WIRE

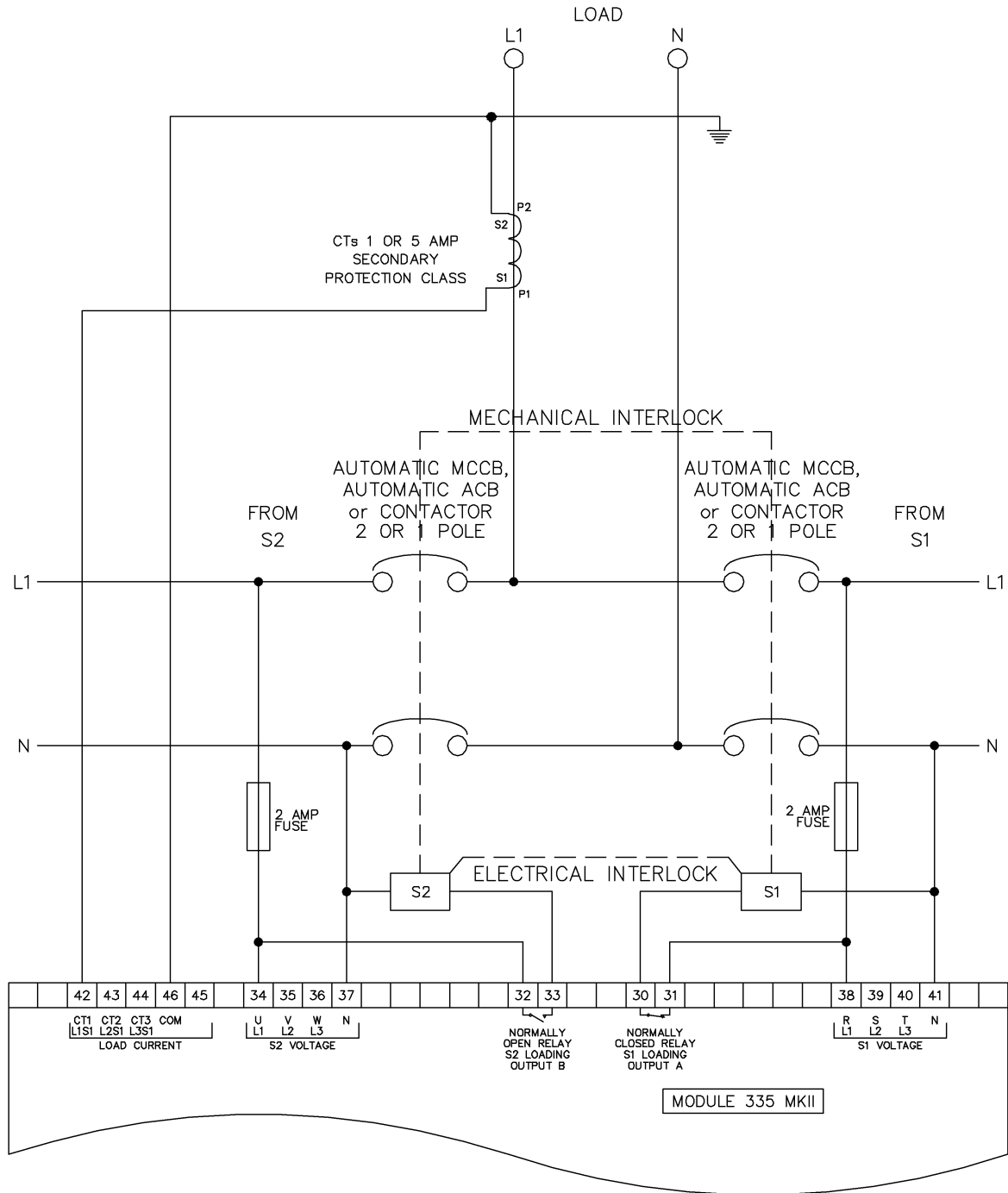

3.5.2 2 PHASE (L1 & L2) 3 WIRE

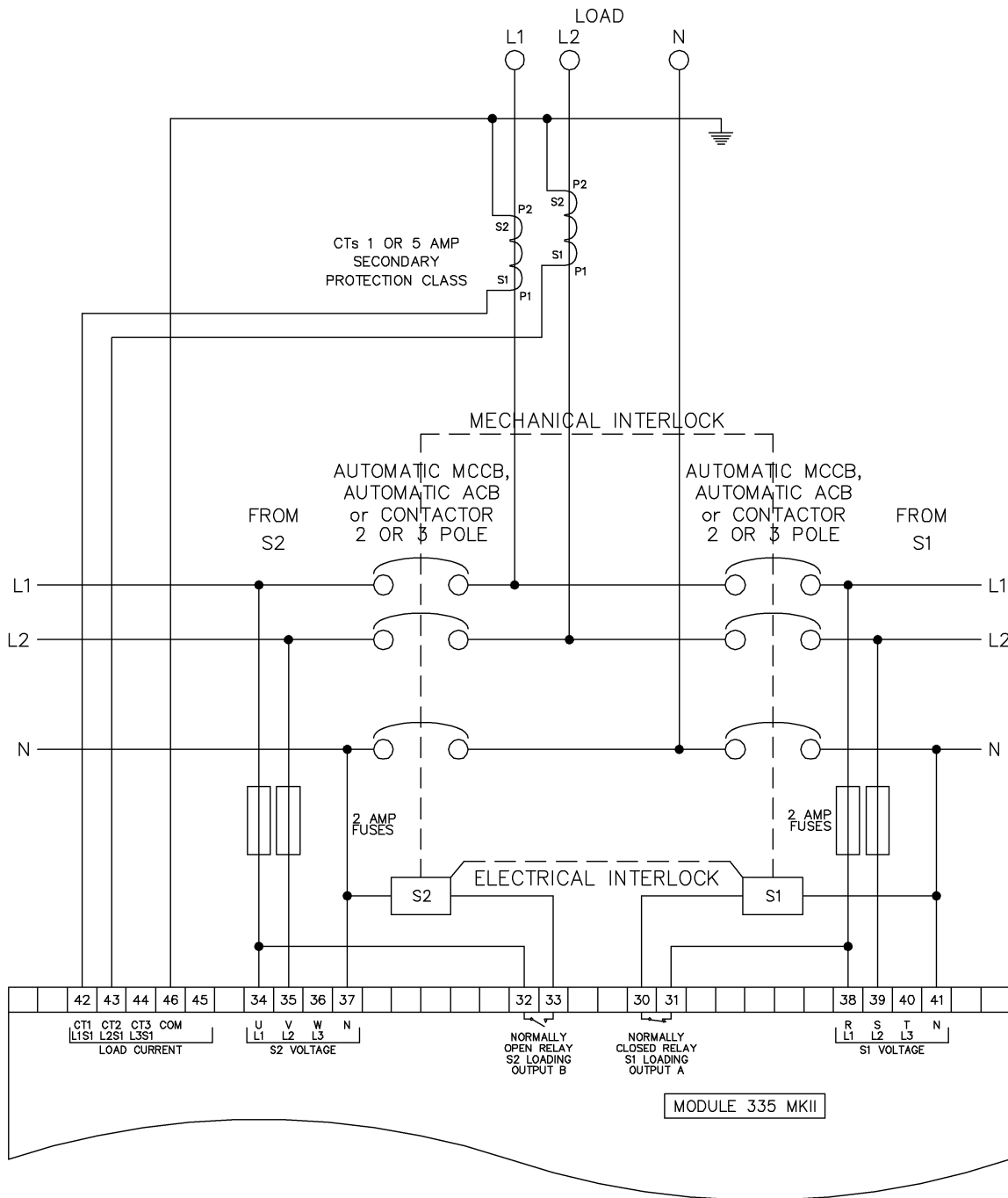

3.5.3 2 PHASE (L1 & L3) 3 WIRE

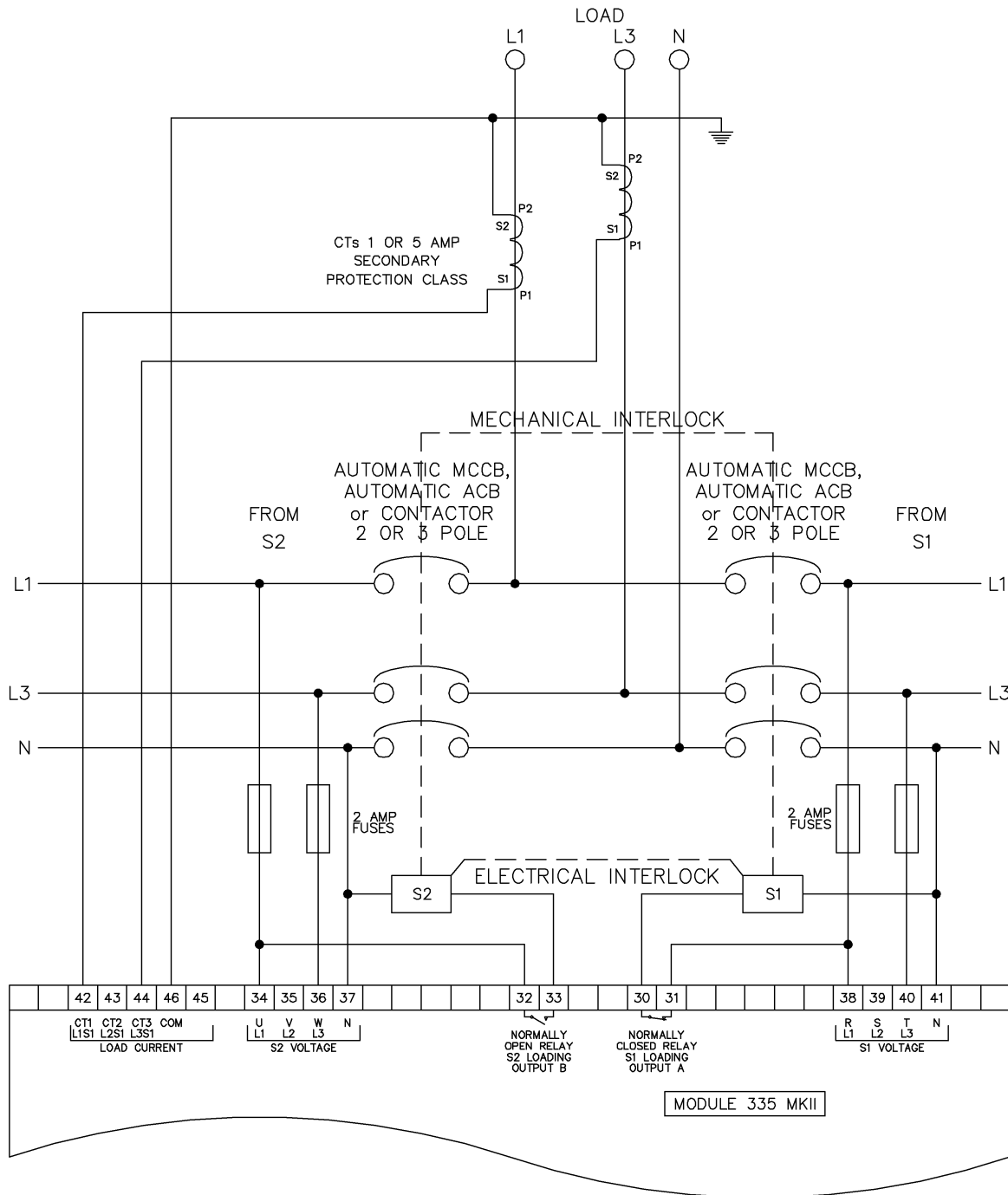

3.5.4 3 PHASE 3 WIRE DELTA

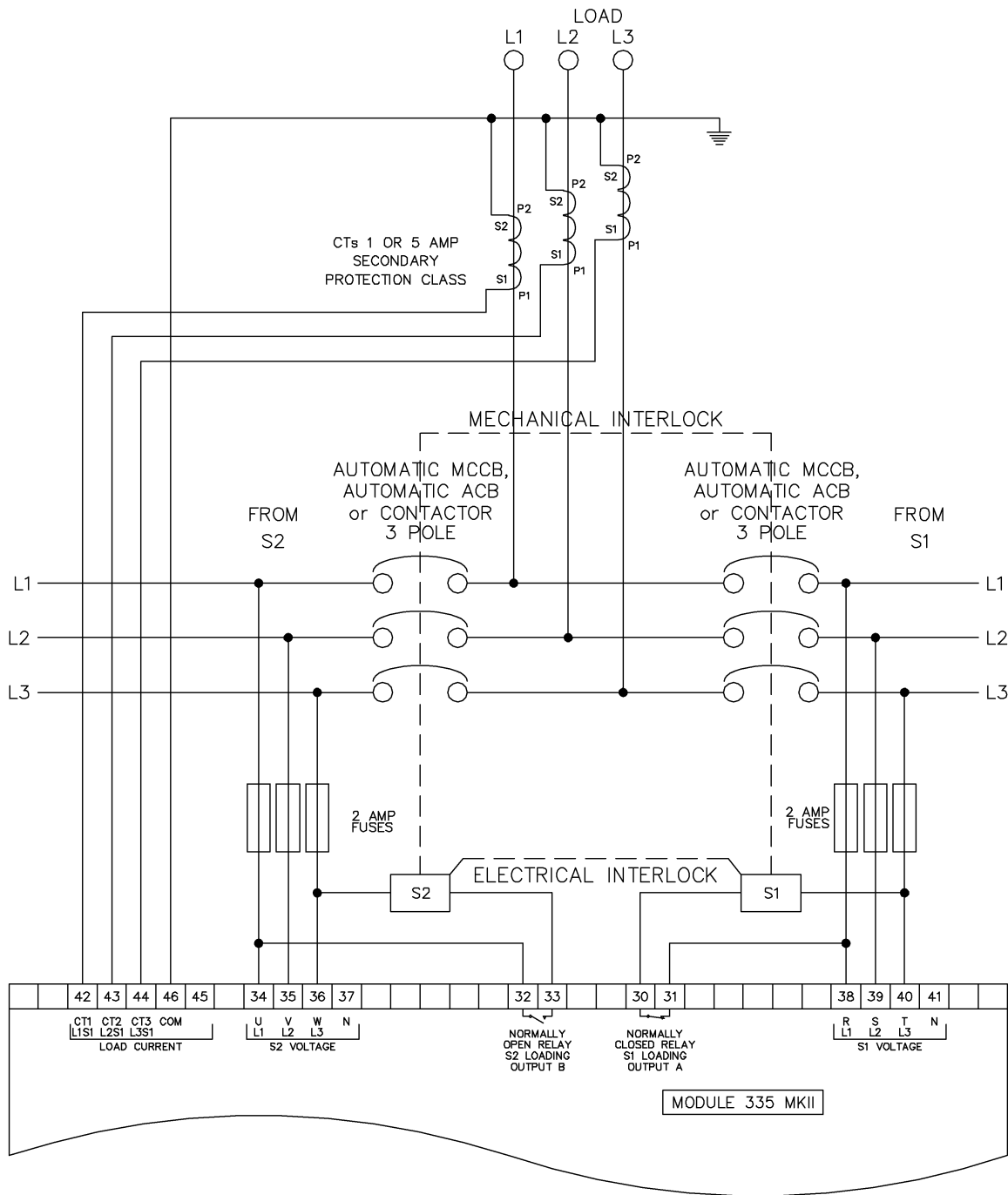

3.5.5 3 PHASE 4 WIRE

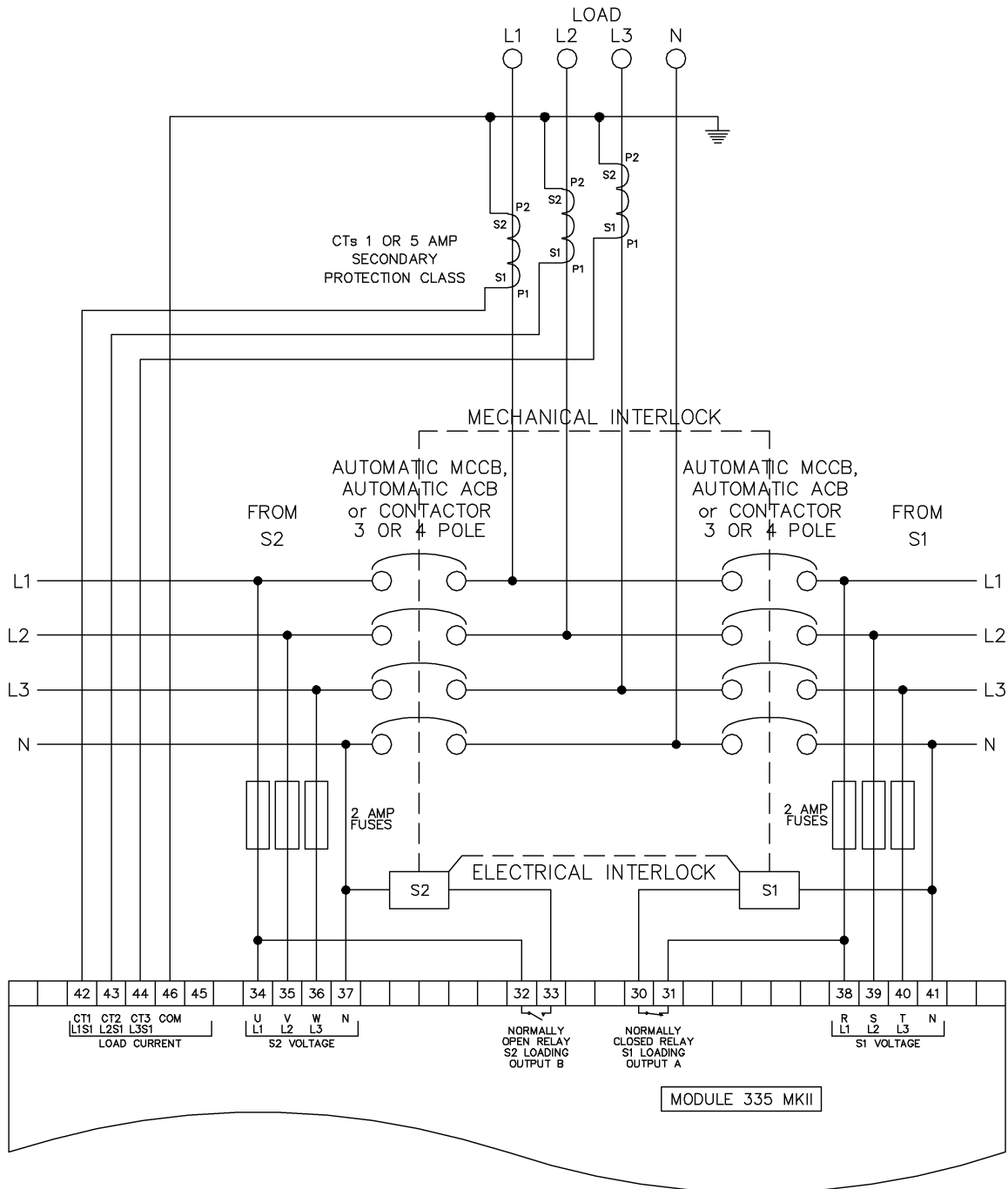











## 4 DESCRIPTION OF CONTROLS

**NOTE:** The following descriptions detail the sequences followed by a module containing the standard 'factory configuration'. Always refer to the configuration source for the exact sequences and timers observed by any particular module in the field.

**CAUTION:** The module may instruct an engine start event due to external influences. Therefore, it is possible for the engine to start at any time without warning. Prior to performing any maintenance on the system, it is recommended that steps are taken to remove the battery and isolate supplies.



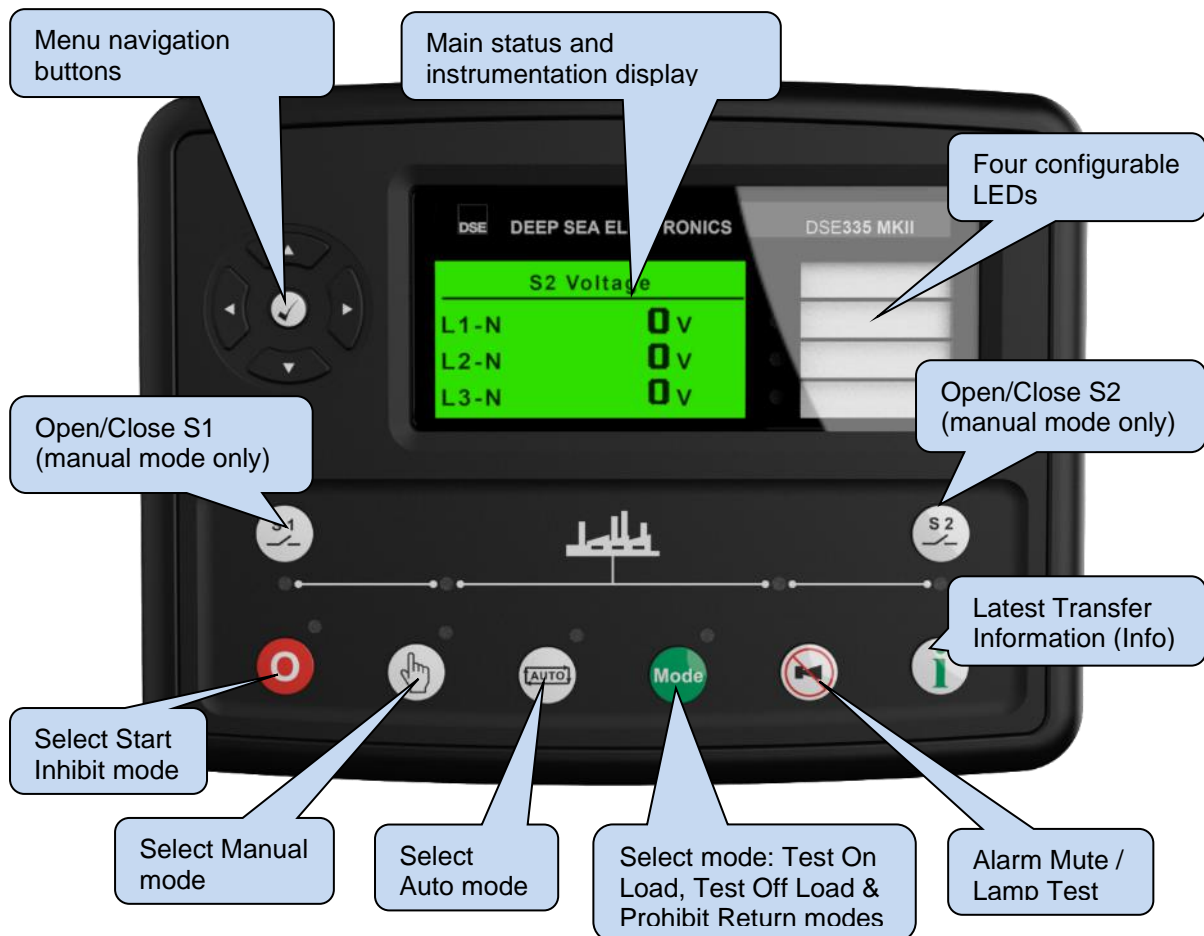



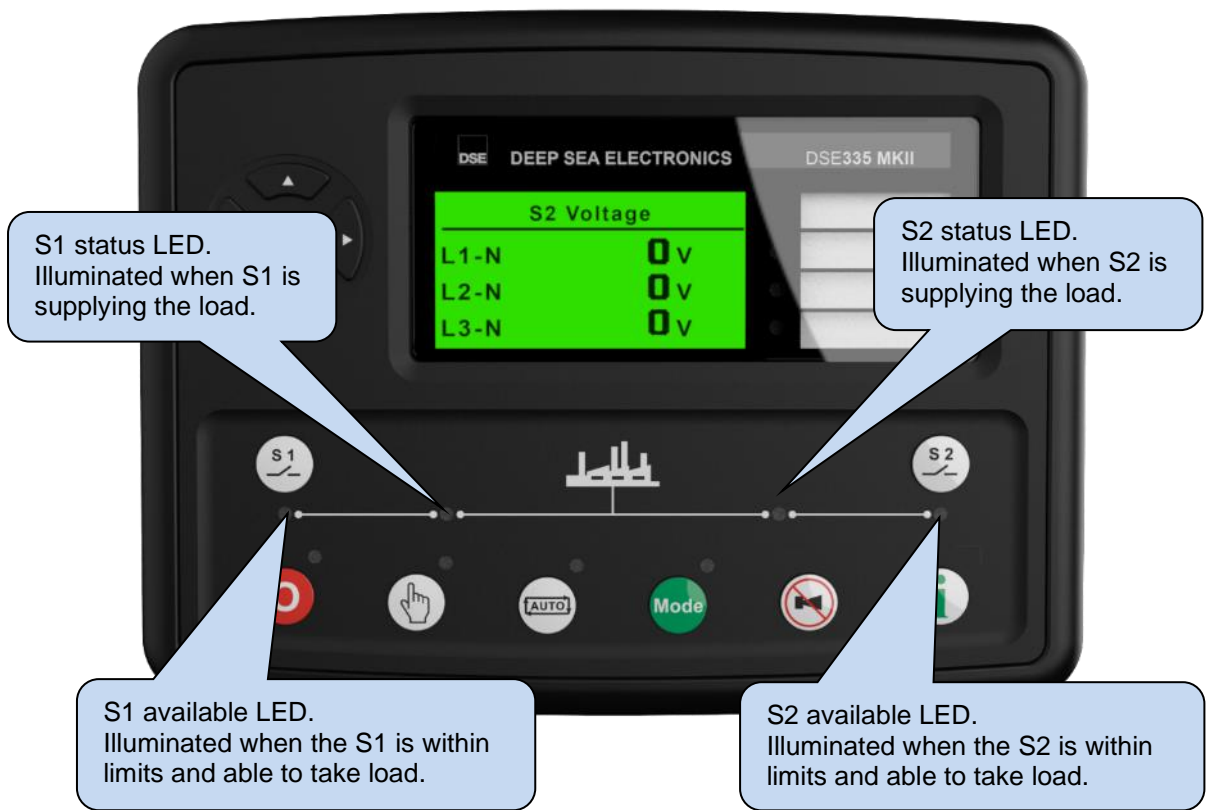

Control of the module is via push buttons mounted on the front of the module with Start Inhibit Mode , Manual Mode , Auto , Mode , Alarm Mute , Latest Transfer Information , Close/Open S1  and Close/Open S2  functions. For normal operation, these are the only controls which need to be operated. Details of their operation are provided later in this document.











Description of Controls



## 4.1 CONTROL PUSH-BUTTONS

Icon	Description
	<p><b>Start Inhibit Mode</b></p> <p>This button places the module into its <b>Start Inhibit Mode</b> . This clears any alarm conditions for which the triggering criteria have been removed. If a source is on load and the module is placed into <b>Start Inhibit Mode</b> , the module automatically instructs the changeover device to transfer from the <i>Standby</i> source to the <i>Priority</i> source. If a Remote Start signal is present while operating in this mode, the remote start does not occur.</p>
	<p><b>Manual Mode</b></p> <p>This button places the module into its <b>Manual Mode</b>  to allow manual control of the ATS functions. This starts S2 when configured as a generator and runs it off load.</p> <p>For further details, please see section entitled <i>Manual Mode</i> elsewhere in this document.</p>
	<p><b>Auto Mode</b></p> <p>This button places the module into its <b>Auto Mode</b> . This mode allows the module to control the function of S1 and S2 automatically. The module monitors the <i>remote start</i> input and S1 supply status and once a start request is made, a start request is given to S2 if configured to a generator and once available, placed on load. Upon removal of the starting signal, the module automatically transfers the load from S2 and remove the start signal to the generator observing the <i>return delay</i> timer and <i>cooling</i> timer as necessary. The module then waits for the next start event. For further details, please see section entitled <i>Automatic Mode</i> elsewhere in this document.</p>
	<p><b>Mode</b></p> <p>This button allows the user to cycle through different operating modes. Pressing the <i>Tick</i>  button accepts the mode change.</p> <p>The modes available are:</p> <p><i>Test On Load:</i> This mode allows the module to start and load S2 for test purposes.</p> <p><i>Test Off Load:</i> This mode allows the module to start S2 and leave off load for test purposes.</p> <p><i>Prohibit Return:</i> This mode is used to prevent the module from returning load the S1 until instructed.</p> <p>For further details, please see section entitled <i>Mode Selection</i> elsewhere in this document.</p>

Icon	Description
	<p><b>Mute / Lamp Test</b></p> <p>This button silences the audible alarm if it is sounding and illuminates all of the LEDs as a lamp test feature.</p>
	<p><b>Latest Transfer Information</b></p> <p>Whilst pressing this button, the module displays the reason, time, date, and duration for the latest transfer that occurred, holding this button cycles between the last S1 transfer and the last S2 transfer.</p> <p>For further details, please see section entitled <i>Viewing Latest Transfer Information Page</i> elsewhere in this document.</p>
	<p><b>Close / Open to S1</b></p> <div style="border: 1px solid black; padding: 5px; margin-bottom: 10px;"> <p><b>▲ NOTE: This button only operates in manual mode.</b></p> </div> <p>Pressing the <i>Close / Open S1</i>  button when S1 is on load, opens the S1 load switch.</p> <p>Pressing the <i>Close / Open S1</i>  button when S2 is on load and S1 is healthy, the S2 load switch opens, wait for the duration of the <i>transfer delay</i>, then closes the S1 load switch.</p> <p>For further details, please see section entitled <i>Manual Mode</i> elsewhere in this document.</p>
	<p><b>Close/Open to S2</b></p> <div style="border: 1px solid black; padding: 5px; margin-bottom: 10px;"> <p><b>▲ NOTE: This button only operates in manual mode.</b></p> </div> <p>Pressing the <i>Close / Open S2</i>  button when S2 is on load, opens the S2 load switch.</p> <p>Pressing the <i>Close / Open S2</i>  button when S1 is on load and S2 is healthy, the S1 load switch opens, wait for the duration of the <i>transfer delay</i>, then closes the S2 load switch.</p> <p>For further details, please see section entitled <i>Manual Mode</i> elsewhere in this document.</p>
	<p><b>Menu navigation</b></p> <p>Used for navigating the instrumentation, event log and configuration screens.</p>

## 4.2 VIEWING THE INSTRUMENT PAGES



**NOTE:** Depending upon the module's configuration, some display screens may be disabled. For further details of module configuration, refer to DSE Publication: 057-367 *DSE335 MKII Configuration Suite PC Software Manual*.

It is possible to scroll to display the different pages of information by repeatedly operating the **Next /**

**Previous** page buttons 

If you want to view one of the instrument pages towards the end of the list, it may be quicker to scroll left through the pages rather than right!

**Example**

Status  S1  S2  Further presses of the **Next Page Button** returns the display to the Status page.

The complete order and contents of each information page are given in the following sections. Once selected the page remains on the LCD display until the user selects a different page, or after an extended period of inactivity (*LCD Page Timer*), the module reverts to the status display. If no buttons are pressed upon entering an instrumentation page, the instruments are displayed automatically subject to the setting of the *LCD Scroll Timer*. The *LCD Page* and *LCD Scroll* timers are configurable using the DSE Configuration Suite Software or by using the Front Panel Editor.





The screenshot shows the factory settings for the timers, taken from the DSE Configuration Suite Software.

Alternatively, to scroll manually through all instruments on the

currently selected page, press the scroll  buttons. The 'autoscroll' is disabled.



If you want to view one of the instruments towards the end of the list, it may be quicker to scroll up through the instruments rather than down!



To re-enable 'autoscroll' press the scroll  buttons to scroll to the 'title' of the instrumentation page (i.e. S1). A short time later (the duration of the *LCD Scroll Timer*), the instrumentation display begins to autoscroll.

When scrolling manually, the display automatically returns to the Status page if no buttons are pressed for the duration of the configurable *LCD Page Timer*. If an alarm becomes active while viewing the status page, the display shows the Alarms page to draw the operator's attention to the alarm condition.

### 4.2.1 STATUS

	<p><b>NOTE:</b> Press the <i>Instrumentation Scroll</i>  buttons on the <i>Status Page</i> to view other Configurable Status Screens if configured. For further details of module configuration, refer to DSE Publication: <i>057-367 DSE335 MKII Configuration Suite PC Software Manual</i>.</p>
---	--

This is the 'home' page, which is displayed when no other page has been selected, and the page that is automatically displayed after a period of inactivity (*LCD Page Timer*) of the module control buttons.

Contains summary information of both supplies along with different module status display.

- Main Summary (Backup source)
- Main Summary (Primary source)
- Source supply summary
- Supervisors summary
- Monitors summary

This page changes with the action of the controller, when S1 is on load, S1 parameters are seen and when changing to S2 on load, the S2 parameters are shown.

<b>No Start Request</b>		
<b>S1 Closed</b>		
L-N	230V	40A
L-L	400V	50.0Hz

Example of the main summary screen showing no start request to S2 and S1 closed supplying the load.

<b>S2 Available</b>		
<b>S2 Closed</b>		
L-N	229V	40A
L-L	399V	50.1Hz

Example screen showing S2 on load.

<b>S1</b>	<b>250A</b>	
<b>230V</b>	<b>50.1Hz</b>	
<b>S2</b>	<b>125A</b>	
<b>229V</b>	<b>50Hz</b>	

Example screen showing source supply summary. This screen provides information on the voltage, current, and frequency of each source.



<b>Start Inhibit</b>	<b>10:52</b>
<b>S1 Failed</b>	
<b>No Start Request</b>	
<b>S1 Failed to Close</b>	

Example screen displaying supervisor summary. This screen provides information on the state of the two sources, the start and return delays, and start and stop requests.

<b>Start Inhibit</b>	<b>10:52</b>
<b>Offline</b>	
<b>Failed</b>	
<b>S2 Failed to Open</b>	

Example screen displaying monitor summary. This screen provides information on the state of the two sources, e.g. whether the source is offline etc.

#### 4.2.2 S1

	<p><b>NOTE:</b> Press the <i>Instrumentation Scroll</i>  buttons on the <i>S1 Page</i> to view other Configurable S1 Screens if configured. For further details of module configuration, refer to DSE Publication: <i>057-367 DSE335 MKII Configuration Suite PC Software Manual</i>.</p>
---	--

Contains electrical values of S1 measured or derived from the module's voltage and current inputs.

- S1 Setup

<b>S1 Setup</b>
<b>Mains Primary Source</b>

Example of the S1 Setup screen. The primary source for power has been designated as S1, which has been connected to the mains.

- S1 State

<b>S1 State</b>
<b>S1 Failed Failed Under Voltage</b>

Example of the S1 State screen. S1 has currently failed due to Under Voltage.

- S1 Summary
- S1 Voltage (ph-N)
- S1 Voltage (ph-ph)
- S1 Frequency
- S1 Phase Sequence
- S1 Load (ph-N kW)
- S1 Load (Total kW)
- S1 Load (ph-N kV A)
- S1 Load (Total kV A)
- S1 Power Factor
- S1 Power Factor Average
- S1 Load (ph-N kvar)
- S1 Load (Total kvar)
- S1 Load (kW h, kV A h, kvar h)

### 4.2.3 S2



**NOTE:** Press the *Instrumentation Scroll*  buttons on the *S1 Page* to view other Configurable S2 Screens if configured. For further details of module configuration, refer to DSE Publication: *057-367 DSE335 MKII Configuration Suite PC Software Manual*.

Contains electrical values of S2 measured or derived from the module's voltage and current inputs.

- S2 Setup

<b>S2 Setup</b>
<b>Mains Primary Source</b>

Example of the S1 Setup screen. The primary source for power is S1, which has been designated to mains.

- S1 State

<b>S2 State</b>
<b>S1 Failed Failed Under Voltage</b>



Example of the S1 State screen. S1 has currently failed due to Under Voltage.

- S2 Summary
- S2 Voltage (ph-N)
- S2 Voltage (ph-ph)
- S2 Frequency
- S2 Phase Sequence
- S2 Load (ph-N kW)
- S2 Load (Total kW)
- S2 Load (ph-N kV A)
- S2 Load (Total kV A)
- S2 Power Factor
- S2 Power Factor Average
- S2 Load (ph-N kvar)
- S2 Load (Total kvar)
- S2 Load (kW h, kV A h, kvar h)
- Load Control



#### 4.2.4 MODULE



**NOTE:** Press the *Instrumentation Scroll* buttons on the *S1 Page* to view other Configurable S2 Screens if configured. For further details of module configuration, refer to DSE Publication: *057-367 DSE335 MKII Configuration Suite PC Software Manual*.

Provides information on primary and secondary sources and their definitions.

<b>S1</b>	S1 source type and priority.
<b>Mains Primary Source</b>	
<b>S2</b>	S2 source type and priority.
<b>Generator Backup Source</b>	
<b>Current Date and Time</b>	Current date and time.
<b>14 Jan 2024,13:24:55</b>	
<b>Battery Voltage</b>	Battery voltage.
<b>Battery    21.4 v</b>	

### 4.2.5 EXPANSION

**NOTE:** Depending upon the module's configuration, some display screens may be disabled. For further details of module configuration, refer to DSE Publication: *057-367 DSE335 MKII Configuration Suite PC Software Manual*.

Contains measured values from various input expansion modules that are connected to the DSE module.

Press the **Instrumentation Scroll**  buttons scroll through the **Expansion** parameters if configured.

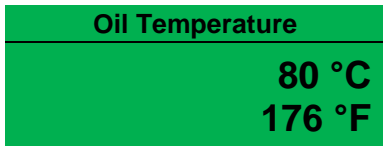

DSE2130 Analogue Inputs (Only appears if configured)  
 DSE2157 Analogue Inputs (Only appears if configured)  
 DSE2548 Analogue Inputs (Only appears if configured)

### 4.2.6 ALARMS

When an alarm is active, the LCD display jumps from the 'Information page' to display the Alarm Page and the *Common Alarm* output if configured, activates.

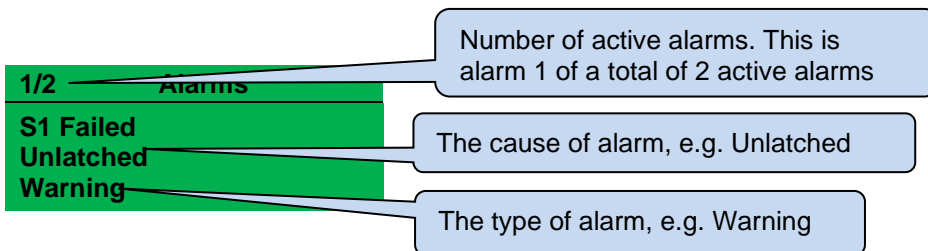

The LCD displays multiple alarms such as "Failed to Close" etc. These automatically scroll in the

order that they occurred or press the **Instrumentation Scroll**  buttons to scroll through manually.

In the event of an alarm, the LCD displays the appropriate text. If an additional alarm then occurs, the module displays the appropriate text.

**Example:**

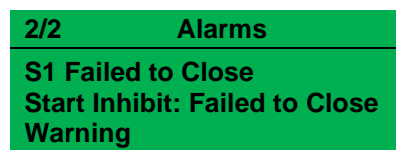
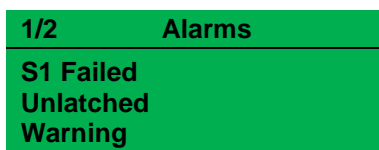

### 4.2.7 EVENT LOG

**NOTE:** For further details of module configuration, refer to DSE Publication: 057-367 *DSE335 MKII Configuration Suite PC Software Manual*.

The module maintains a log of past alarms and/or selected status changes. The log size has been increased in the module over past module updates and is always subject to change. At the time of writing, the modules log is capable of storing the last 250 log entries.

Under default factory settings, the event log is configured to include all possible options; however, this is configurable by the system designer using the DSE Configuration Suite software.

The screenshot shows the 'Event Log' configuration window. Under 'Logging Options', there is a section 'Log the following events to the event log' with two columns of checkboxes. The first column includes: Power-Up, S1 return, S1 fail, S2 return, and S2 fail. The second column includes: Electrical Trip Alarms, Latched warnings, Unlatched warnings, Breaker Failures, and Incorrect Password Entered. All checkboxes are checked. A callout box on the right says: 'Example showing the possible configuration of the modules event log (DSE Configuration Suite Software) This also shows the factory settings of the module.'

When the event log is full, any subsequent event overwrites the oldest entry. Hence, the event log always contains the most recent events. The module logs the event type, along with the date and time (or engine running hours if configured to do so).

To view the event log, repeatedly press the next page button  until the LCD screen displays the Event log :

The LCD screen displays a green background with white text. It shows '1 Event log 11:33' at the top, followed by 'S1 Failure Warning' and '23 Mar 2014, 08:25:46'. A callout box on the left says 'This is event 1.'

Press the **Scroll Down**  button to view the next most recent event.

Continuing to press the **Scroll Down**  button cycles through the past events after which, the display shows the most recent alarm, and the cycle begins again.

To exit the event log and return to viewing the instruments, press the **Next or Previous Page**  buttons to select the next instrumentation page.

#### 4.2.8 SCHEDULE

**NOTE:** For further details on the operation of the inbuilt scheduler feature, refer to section entitled *Scheduler* in the *Operation* section of this document.

**NOTE:** For further details of module configuration, refer to DSE Publication: 057-367 *DSE335 MKII Configuration Suite PC Software Manual*.

The controller contains an inbuilt exercise run scheduler, capable of automatically starting and stopping the set or inhibiting the set from starting. Up to 16 scheduled (in two banks of 8) start/stop/inhibiting start sequences may be configured to repeat on a 7-day or 28-day cycle.

Scheduled runs may be on load or off load depending upon module configuration.

This section of the module's display shows how exactly the scheduler (if enabled) is configured. Under default factory settings the Schedule is not viewable. It is enabled by the system designer using the DSE Configuration Suite software.

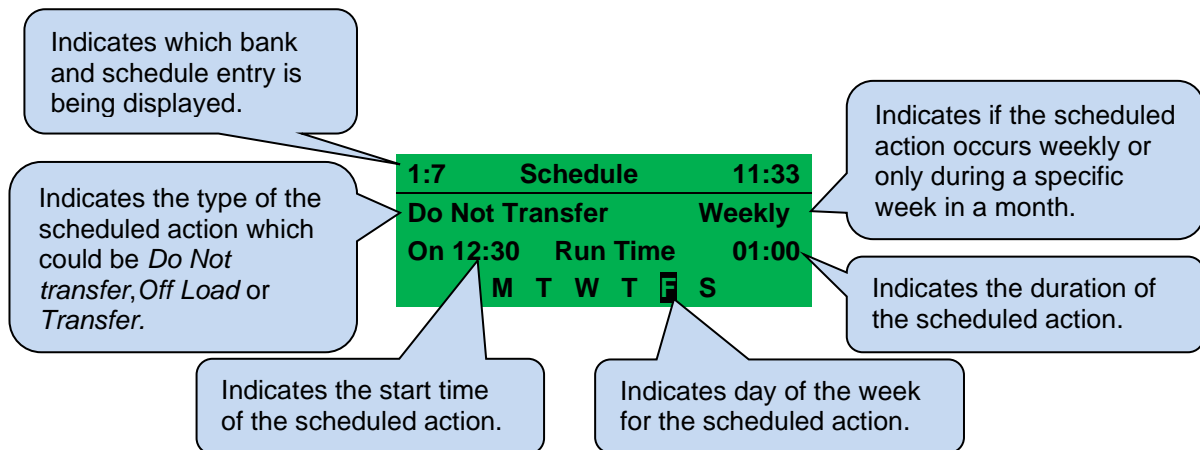

### 4.2.9 ABOUT

Contains important information about the module and the firmware versions. This information may be asked for when contacting DSE Technical Support Department for advice.

About	
Variant	335
Application	V1.0.7
USB ID	12CC340F8

- Variant – 335
- Application Version – The version of the module's main firmware file (Updatable using the Firmware Update Wizard in the DSE Configuration Suite Software).
- USB ID – Unique identifier for PC USB connection

Press  to access more information about the module.

About	
Bootloader	V1.2.12

- Bootloader - Firmware Update bootloader software version

### 4.3 VIEWING LATEST TRANSFER INFORMATION PAGE

It is possible to view the reason, time, date, and duration of the latest transfer by pressing and holding the *Latest Transfer Information* . Holding this button cycles between the last S1 transfer and the last S2 transfer.

S1 Latest Transfer	16:53
S2 Under Voltage	
22 Oct 2014, 12:59:47	
00:27:13	

Example of the Latest Transfer page which shows that there was a transfer cause by an S1 Under Voltage failure which lasted for 27 minutes and 13 seconds.

#### 4.4 USER CONFIGURABLE INDICATORS

These LEDs are capable of being configured by the user to indicate any one of **100+ different functions** based around the following:

- **Indications** - Monitoring of a digital input and indicating associated functioning user's equipment - *Such as Battery Charger On or Louvres Open, etc.*
- **Warning & Electrical Trips** - Specific indication of a particular warning or electrical trip condition, backed up by LCD indication - *Such as S2 Under Voltage Trip, Transformer Over Temperature, etc.*
- **Status Indications** - Indication of specific functions or sequences derived from the modules operating state - *Such as, Panel Locked, S2 Available, etc.*



## 5 OPERATION

**NOTE:** The following descriptions detail the sequences followed by a module containing the standard 'factory configuration'. Always refer to the configuration source for the exact sequences and timers observed by any particular module in the field.

### 5.1 QUICKSTART GUIDE

This section provides a quick start guide to the module's operation.

#### 5.1.1 STARTING S2

**NOTE:** This only applies when S2 is configured as a generator supply.



### 5.1.2 STOPPING S2

**NOTE:** This only applies when S2 is configured as a generator supply.





Select **Start Inhibit Mode**  S2 breaker is opened, and the start request is removed from S2. The load transfers to the priority source (if set as S1) and close the breaker on that source.



## 5.2 START INHIBIT MODE

 **NOTE:** If a digital input configured to *Panel Lock* is active, changing module modes is not possible. Viewing the instruments and event logs is NOT affected by panel lock.

**Start Inhibit Mode** is activated by pressing the **Start Inhibit Mode**  button.

The LED above the **Start Inhibit Mode**  button illuminates to indicate **Start Inhibit Mode**  operation.



In **Start Inhibit Mode** , the module removes S2 or S1 from load (whichever is set as a priority) and removes the start signal given to the generator controller (if S2 is configured as a generator and it is running).

A S2 start request is initiated if it is set up as a generator regardless of S1's configuration. However, there is no need for a Start Request for S1 if it is configured as a generator, as S1 functions as a priority source and is anticipated to operate seamlessly without necessitating a start request.

If S2 is configured as a generator and it does not stop after the cooling down time, the *Fail To Stop* alarm is activated (subject to the *Fail To Stop* timer being enabled and its duration). To detect the generator (S2) is at rest the following must occur:

- S2 Frequency must be zero
- S2 Voltage must be zero

Any latched alarms that have been cleared are reset when **Start Inhibit Mode**  is entered.

The standby source is not placed on load (or started if configured as a generator) when in **Start Inhibit Mode** . If remote start signals are given, the input is ignored until **Auto Mode**  is entered.

## 5.3 MANUAL MODE

 **NOTE:** If a digital input configured to *Panel Lock* is active, changing module modes is not possible. Viewing the instruments and event logs is NOT affected by panel lock.

**Manual Mode** is activated by pressing the **Manual Mode**  button.

In **Manual Mode** , the module activates an output to give a start signal to an external generator controller (if S2 is configured as a generator supply), and if required, change the state of the load switching devices. An LED indicator beside the button confirms this action.

### 5.3.1 STARTING SEQUENCE

 **NOTE:** There is no *start delay* in this mode of operation.

As soon as the **Manual Mode**  button is pressed, the output to give a start signal to an external generator controller is activated (if S2 is configured as a generator)

If the generator fails to start during the 'S2 Fail Delay' timer, an alarm appears on the display which shows *Fail to Start*. S2 is seen as available once the supply is within limits (if configured as a mains supply) or had achieved loading voltage and frequency (if configured as a generator).

### 5.3.2 S2 AVAILABLE

 **NOTE: The load transfer signal remains inactive until S2 is seen as available. This prevents loading to a supply that has failed or is not yet available.**

In **Manual Mode** , the load is not transferred to S2 unless a 'loading request' is made and the S2 supply is within limits (if configured as a mains supply) or achieve *Loading Voltage* and *Loading Frequency* (if configured as a generator).

A loading request may originate from various sources.

- Pressing the *Close/Open S2*  button
- S1 supply out of limits
- Activation of an auxiliary input that has been configured to *remote start on load*
- Activation of the inbuilt exercise scheduler if configured for 'on load' runs.

As the load increases and decreases, the module may (depending upon configuration) remove non-essential loads. This is configured as part of the *Load Shedding* control settings in the DSE Configuration Suite Software.

See section entitled **Error! Reference source not found.** elsewhere in this document.

Once the load has been transferred to S2, it is not automatically transferred back to the S1 supply. To manually transfer the load back to the mains either:

- Pressing the *Close/Open S1*  button
- Pressing the **Auto Mode**  button to return to automatic mode.
- Pressing the **Start Inhibit Mode**  button to return to start inhibit mode.

For further details of breaker control, see the section entitled **Error! Reference source not found.** elsewhere in this document.

### 5.3.3 STOPPING SEQUENCE

In manual mode, S2 continues to run until either:

- Pressing the **Start Inhibit Mode**  button to return to start inhibit mode.
- Pressing the **Auto Mode**  button to return to automatic mode.

## 5.4 AUTOMATIC MODE

 **NOTE:** If a digital input configured to *Panel Lock* is active, changing module modes is not possible. Viewing the instruments and event logs is NOT affected by panel lock.

Auto mode is activated by pressing the **Auto Mode**  button.

In **Auto Mode**  mode, the module operates fully automatically, changing between the two supplies in case of failure without user intervention. An LED indicator beside the button confirms this action.

### 5.4.1 WAITING IN AUTO MODE

If a starting/loading request is made, the starting sequence begins. Starting/loading requests may originate from the following sources:

- S1 supply out of limits
- Activation of an auxiliary input that has been configured to *remote start on load* or *remote start off load*.
- Activation of the inbuilt exercise scheduler.
- Instruction from external remote telemetry devices using the RS485 interface

### 5.4.2 STARTING SEQUENCE

To allow for 'false' start/load requests such as S1 brownouts, the *Start Delay* timer begins. There are individual start delay timers for each of the different start/load request types.

When all start/load requests are removed during the *Start Delay* timer, the unit returns to a stand-by state.

If a start/load request is still present at the end of the *Start Delay* timer, an output to give a start signal to an external generator controller is activated (if S2 is configured as a generator).

If the generator fails to start during the 'S2 Fail Delay' timer, an alarm appears on the display which shows *Fail to Start*. S2 is seen as available once the supply is within limits (if configured as a mains supply) or had achieved *Loading Voltage* and *Loading Frequency* (if configured as a generator).

If a start/load request is currently in place but the starting sequence has not yet commenced, it is possible that there is an active input configured for *Auto Start Inhibit*.

### 5.4.3 S2 AVAILABLE

In **Auto Mode**  mode, the load is automatically transferred to S2 when it is within limits (if configured as a mains supply) or achieve loading voltage and frequency (if configured as a generator).

If a start/load request is detected but S2 fails to go on load, it is possible that there is an active input configured for *S2 Load Inhibit*.

A loading request may originate from a number of sources.

- S1 supply out of limits
- Activation of an auxiliary input that has been configured to *remote start on load*
- Activation of the inbuilt exercise scheduler if configured for 'on load' runs.

 **NOTE: The load transfer signal remains inactive until S2 is seen as available. This prevents loading to a supply that has failed or is not yet available.**

As the load increases and decreases, the module may (depending upon configuration) remove non-essential loads. This is configured as part of the *Load Shedding* control settings in the DSE Configuration Suite Software.

See section entitled **Error! Reference source not found.** elsewhere in this document.

If all start/load requests are removed, the *stopping sequence* begins.

### 5.4.4 STOPPING SEQUENCE

The *Return Delay* timer operates to ensure that the start/load request has been permanently removed and isn't just a short term removal. In case another start request is made during the *Return Delay* (or cooling down period when S2 is configured as a generator), the set returns on load.

If there are no starting requests at the end of the *Return Delay* timer, the load is transferred back from the S2 to the S1 supply, and the *Cooling* timer is initiated (when S2 is configured as a generator).

The *Cooling* timer allows S2 (when configured as a generator) to run off load and cool sufficiently before the start signal to the external generator control unit is removed. This is particularly important where turbo chargers are fitted to the engine.



After the *Cooling* timer has expired, the start signal given to the external generator controller is removed..

## 5.5 MODE SELECTION

 **NOTE:** If a digital input configured to *Panel Lock* is active, changing module modes is not possible. Viewing the instruments and event logs is NOT affected by panel lock.



Pressing the **Mode**  button sets which of the three modes below to leave the controller in.

### 5.5.1 TEST ON LOAD

Activate by pressing the **Mode**  button repeatedly until *Test on Load* is shown on the display, then press the **Tick**  button to confirm the change. An LED indicator beside the button confirms this action.

The *Test on Load* mode starts S2 (if configured as a generator) and transfers the load to S2.

#### 5.5.1.1 STARTING SEQUENCE

As soon as the **Mode**  is selected and confirmed by pressing the **Tick**  button is pressed, the output to give a start signal to an external generator controller is activated (if S2 is configured as a generator)

If the generator fails to start during the 'S2 Fail Delay' timer, an alarm appears on the display which shows *Fail to Start*. S2 is seen as available once the supply is within limits (if configured as a mains supply) or had achieved *Loading Voltage* and *Loading Frequency* (if configured as a generator).

#### 5.5.1.2 S2 AVAILABLE

In *Test on Load* mode, the load is automatically transferred to S2 when it is within limits (if configured as a mains supply) or had achieved loading voltage and frequency (if configured as a generator).

If a start/load request is detected but S2 fails to go on load, it is possible that there is an active input configured for *S2 Load Inhibit*.

 **NOTE:** The load transfer signal remains inactive until S2 is seen as available. This prevents loading to a supply that has failed or is not yet available.

As the load increases and decreases, the module may (depending upon configuration) remove non-essential loads. This is configured as part of the *Load Shedding* control settings in the DSE Configuration Suite Software.



See section **Error! Reference source not found.** elsewhere in this document.

#### 5.5.1.3 STOPPING SEQUENCE

In *Test on Load* mode, S2 continues to run on load until either:



- Pressing the **Start Inhibit Mode**  button to return to *Start Inhibit* mode.
- Pressing the **Auto Mode**  button to return to automatic mode.

## 5.5.2 TEST OFF LOAD

Activate by pressing the **Mode**  button repeatedly until *Test off Load* is shown on the display, then press the **Tick**  button to confirm the change. An LED indicator beside the button confirms this action.

The *Test off Load* mode only starts S2 (if configured as a generator) and leave it off load.

### 5.5.2.1 STARTING SEQUENCE

As soon as the **Mode**  is selected and confirmed by pressing the **Tick**  button is pressed, the output to give a start signal to an external generator controller is activated (if S2 is configured as a generator)

If the generator fails to start during the *S2 Fail Delay* timer, an alarm appears on the display which shows *Fail to Start*. S2 is seen as available once the supply is within limits (if configured as a mains supply) or had achieved *Loading Voltage* and *Loading Frequency* (if configured as a generator).

### 5.5.2.2 S2 AVAILABLE

In *Test Off Load* mode, the load is not transferred to S2 unless a 'loading request' is made and the S2 supply is within limits (if configured as a mains supply) or has achieved loading voltage and frequency (if configured as a generator).

A loading request may originate from a number of sources.

- S1 supply out of limits
- Activation of an auxiliary input that has been configured to *remote start on load*
- Activation of the inbuilt exercise scheduler if configured for 'on load' runs.

 **NOTE: The load transfer signal remains inactive until S2 is seen as available. This prevents loading to a supply that has failed or is not yet available.**

As the load increases and decreases, the module may (depending upon configuration) remove non-essential loads. This is configured as part of the *Load Shedding* control settings in the DSE Configuration Suite Software.



See section **Error! Reference source not found.** elsewhere in this document.

### 5.5.2.3 STOPPING SEQUENCE

In *Test off Load* mode, S2 continues to run on load until either:

- Pressing the **Start Inhibit Mode**  button to return to *Start Inhibit mode*.
- Pressing the **Auto Mode**  button to return to *Automatic* mode.

### 5.5.3 PROHIBIT RETURN

Activate by pressing the **Mode**  button repeatedly until *Prohibit Return* is shown on the display, then press the **Tick**  button to confirm the change. An LED indicator beside the button confirms this action.

The *Prohibit Return* mode prevents the load being transfer back to the S1 from the S2 supply until the module is instructed to do so.

#### 5.5.3.1 WAITING IN PROHIBIT RETURN

If a starting/loading request is made, the starting sequence begins. Starting/loading requests may originate from the following sources:

- S1 supply out of limits
- Activation of an auxiliary input that has been configured to *Remote Start On Load* or *Remote Start Off Load*.
- Activation of the inbuilt exercise scheduler.
- Instruction from external remote telemetry devices using the RS485 interface

#### 5.5.3.2 STARTING SEQUENCE

To allow for 'false' start/load requests such as S1 brownouts, the *Start Delay* timer begins. There are individual *Start Delay* timers for each of the different start/load request types.

When all start/load requests are removed during the *Start Delay* timer, the unit returns to a stand-by state.

If a start/load request is still present at the end of the *Start Delay* timer, an output to give a start signal to an external generator controller is activated (if S2 is configured as a generator).

If the generator fails to start during the 'S2 Fail Delay' timer, an alarm appears on the display which shows *Fail to Start*. S2 is seen as available once the supply is within limits (if configured as a mains supply) or had achieved *Loading Voltage* and *Loading Frequency* (if configured as a generator).

If a start/load request is present but the starting sequence has not begun, an input configured to '*Auto Start Inhibit*' may be active.

### 5.5.3.3 S2 AVAILABLE

In *Prohibit Return* mode, the load is automatically transferred to S2 when it is within limits (if configured as a mains supply) or has achieved *Loading Voltage* and *Loading Frequency* (if configured as a generator).

If a start/load request is present but S2 does not go on load, an input configured to '*S2 Load Inhibit*' may be active.

A loading request may originate from a number of sources.

- S1 supply out of limits
- Activation of an auxiliary input that has been configured to *Remote Start On Load*
- Activation of the inbuilt exercise scheduler if configured for 'on load' runs.

 **NOTE: The load transfer signal remains inactive until S2 is seen as available. This prevents loading to a supply that has failed or is not yet available.**

As the load increases and decreases, the module may (depending upon configuration) remove non-essential loads. This is configured as part of the *Load Shedding* control settings in the DSE Configuration Suite Software.

See section ***Error! Reference source not found.*** elsewhere in this document.

If all start requests are removed the return delay commences. The status display shows "Waiting for Manual Restore" after the return delay, and the load remains on the standby source. The user must transfer the load back, either by changing to Auto mode (which causes the load to transfer and the cooldown timer to start if the standby source is a generator) or changing to start inhibit mode (which causes the load to transfer or immediately stop if the standby source is a generator).

### 5.5.3.4 STOPPING SEQUENCE

In *Return Inhibit* mode, S2 continues to run on load even if S1 has return until either:

- Pressing the ***Start Inhibit Mode***  button to return to start inhibit mode.
- Pressing the ***Auto Mode***  button to return to automatic mode.



## 5.6 SCHEDULER

The controller contains an inbuilt exercise run scheduler, capable of automatically starting and stopping the set. Up to 16 scheduled start/stop sequences may be configured in banks of 8 to either repeat on a 7-day or 28-day cycle.

Scheduled runs may be on load or off load depending upon module configuration.

Example

Screen capture from DSE Configuration Suite Software showing the configuration of the Exercise Scheduler.

In this example the set starts at 09:00 on the first Monday of each month and run for 5 hours, then start at 13:30 on every Tuesday and run for 30 minutes.

Week	Day	Transfer Mode	Start Time	Duration	
First	Monday	Off Load	09:00	05:00	Clear
Second	Monday	Transfer	13:30	00:30	Clear
First	Monday	Do Not Transfer	00:00	00:00	Clear
First	Monday	Do Not Transfer	00:00	00:00	Clear
First	Monday	Do Not Transfer	00:00	00:00	Clear
First	Monday	Do Not Transfer	00:00	00:00	Clear
First	Monday	Do Not Transfer	00:00	00:00	Clear
First	Monday	Do Not Transfer	00:00	00:00	Clear

### 5.6.1 START INHIBIT MODE

- Scheduled runs do not occur when the module is in **Start Inhibit Mode**

### 5.6.2 MANUAL MODE

- Scheduled runs do not occur when the module is in **Manual Mode**
- Activation of a Scheduled Run 'On Load' when the module is operating Off Load in Manual mode has no effect, the set continues to run Off Load

### 5.6.3 AUTO MODE

- Scheduled runs operate ONLY if the module is in **Auto Mode**
- If the module is in **Start Inhibit Mode** or **Manual Mode** when a scheduled run begins, S2 is not started (if configured as generator). However, if the module is moved into **Auto Mode** during a scheduled run, S2 is called to start.
- Depending upon configuration by the system designer, an external input may be used to inhibit a scheduled run.
- If S2 is Off Load in **Auto Mode** and a scheduled run configured to 'Transfer to S2' begins, S2 is placed On Load for the duration of the Schedule.

## 5.7 CHANGEOVER FUNCTIONALITY

The changeover functionality between S1 and S2 is dependent on how the DSE module is configured. A brief description of the operation of each scheme is detailed in the following sections.

### 5.7.1 OPEN TRANSITION WITHOUT CHECK SYNC

**NOTE:** When using *Open Transition*, it is recommended that digital inputs are configured for *S2 Closed Auxiliary* and *S1 Closed Auxiliary* to provide additional interlock protection.

By default, the DSE module performs an open transition without check sync, with a pre-configured transfer delay between opening one load switch and closing the other. When changing over from S1 to S2, the module requests that the S1 load switch opens. Once the *S1 Closed Auxiliary* indicates the mains load switch has opened, the *Transfer Time* begins. After the *Transfer Time* expires, the module attempts to close the S2 load switch. The operating philosophy is the same when going from S2 to S1 and the complete transition is shown below in the timing diagram.

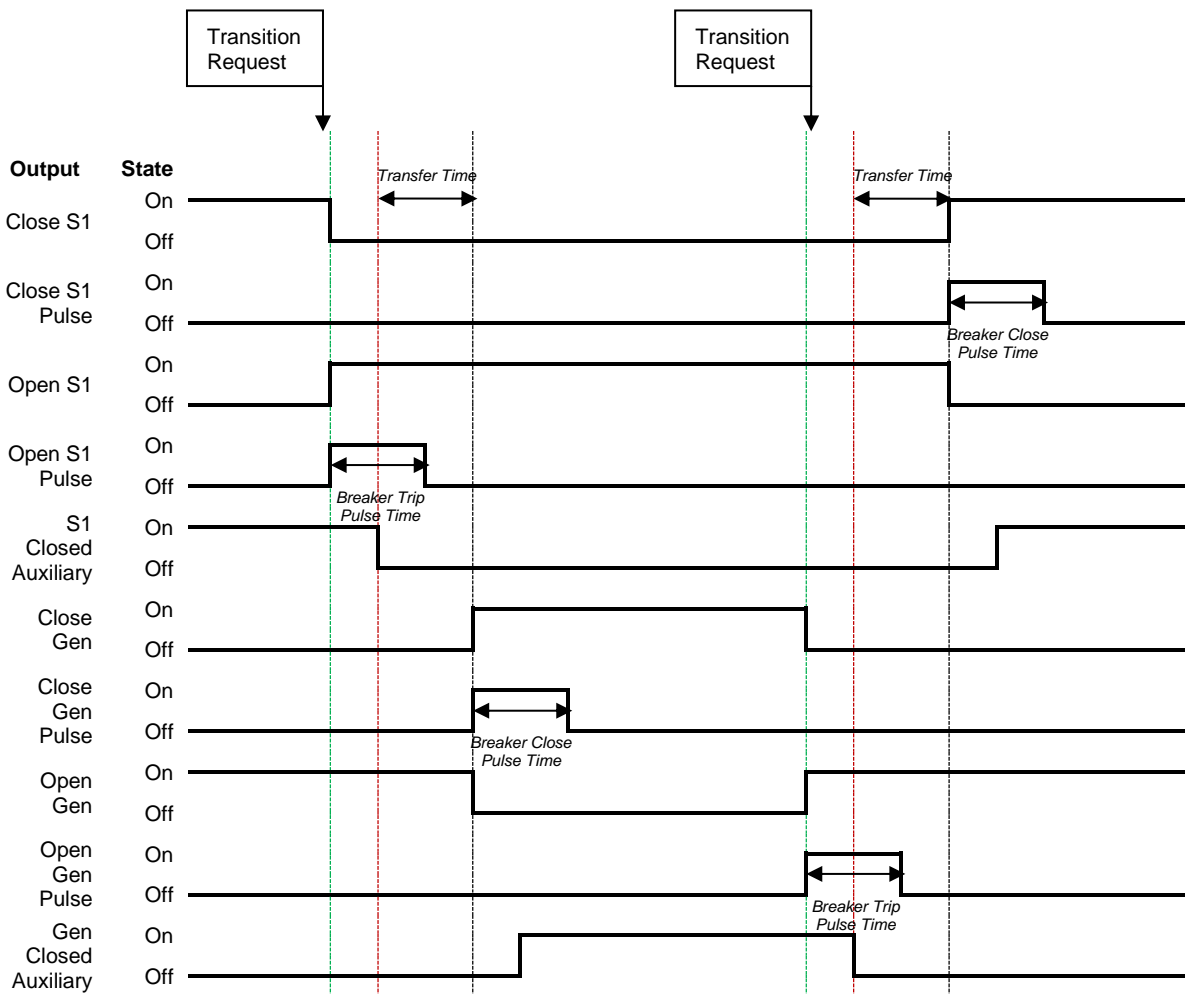

### 5.7.2 OPEN TRANSITION WITH CHECK SYNC

**NOTE:** When using *Open Transition*, it is recommended that digital inputs are configured for *S2 Closed Auxiliary* and *S1 Closed Auxiliary* to provide additional interlock protection.

**NOTE:** It is advised that the *Return to Open Transition* is enabled when *Check Sync* is enabled. If *Return to Open Transition* is enabled, the module performs an open transition without check sync if the supplies fail to drift into synchronism within the configured time. For further details of module configuration, refer to DSE Publication: *057-367 DSE335 MKII Configuration Software Manual*.

It is possible to configure the DSE module to perform an open transition with check sync, with a pre-configured transfer delay between opening one load switch and closing the other. When changing over from S1 to S2, the module waits for the two supplies to become in sync (by passive or actively synchronising depending on configuration). After the supplies become in sync, the module requests that the S1 load switch opens. Once the *S1 Closed Auxiliary* indicates the S1 load switch has opened, the *Transfer Time* begins. After the *Transfer Time* expires, the module attempts to close the S2 load switch. The operating philosophy is the same when going from S2 to S1 and the complete transition is shown below in the timing diagram.

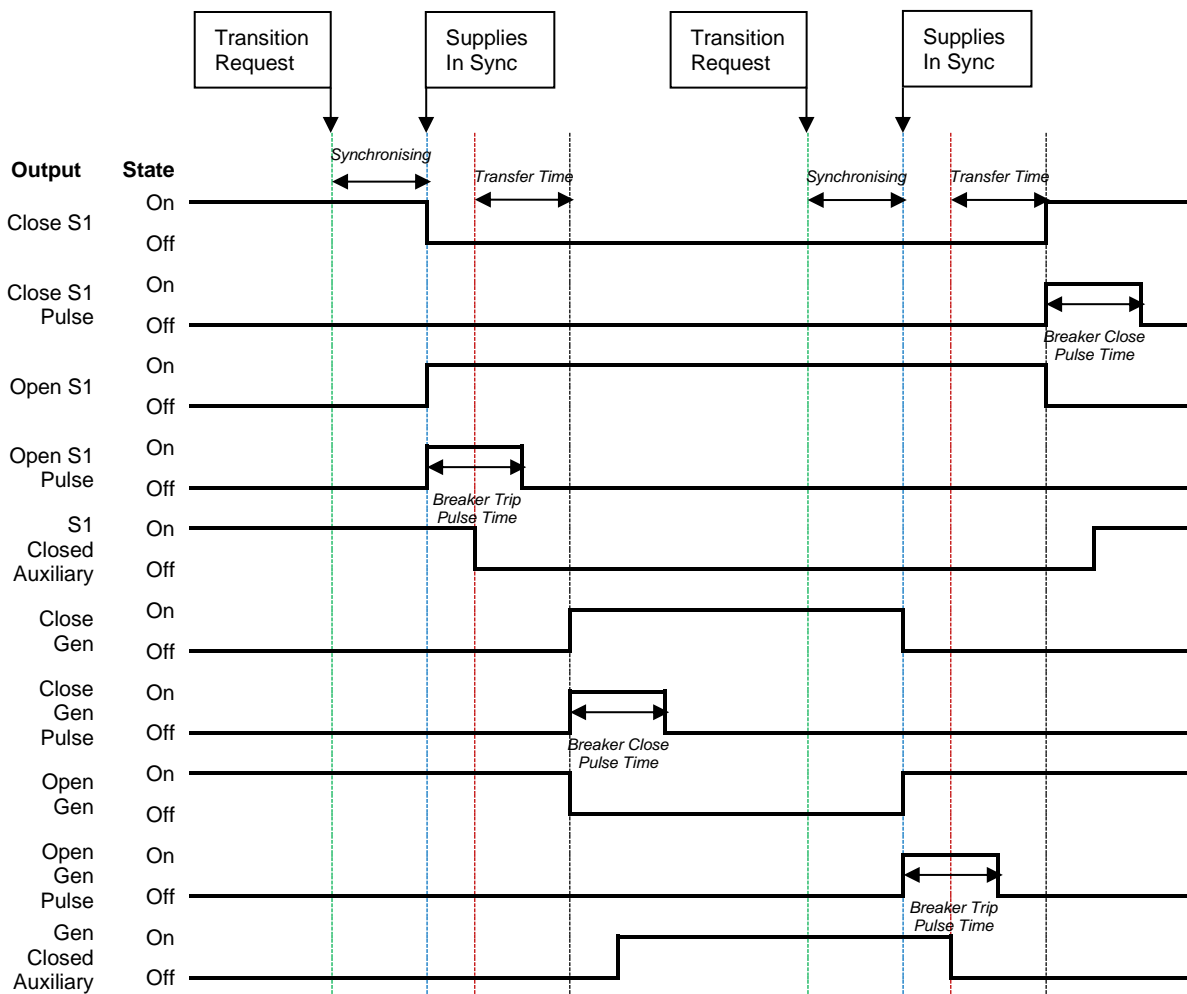

### 5.7.3 CLOSED TRANSITION WITH CHECK SYNC

**NOTE:** When using *Closed Transition With Check Sync*, digital inputs must be configured for *S2 Closed Auxiliary* and *S1 Closed Auxiliary*.

**NOTE:** When using *Closed Transition With Check Sync*, mechanical interlock must not be fitted. It is recommended that external electrical interlock provided but overridden using an output configured as *Interlock Override*.

**NOTE:** It is advised that the *Return to Open Transition* is enabled when *Check Sync* is enabled. If *Return to Open Transition* is enabled, the module performs an open transition without check sync if the supplies fail to drift into synchronism within the configured time. For further details of module configuration, refer to DSE Publication: *057-367 DSE335 MKII Configuration Software Manual*.

It is possible to configure the DSE module to perform a closed transition with check sync, with a pre-configured parallel time when both load switches are closed. When changing over from S1 to S2, the module waits for the two supplies to become in sync (by passive or actively synchronising depending on configuration). After the supplies become in sync, the module requests that the S2 load switch closes. Once the *S2 Closed Auxiliary* indicates the S2 load switch has closed, the *Paralleling Time* begins. After the *Paralleling Time* expires, the module attempts to open the S1 load switch. The operating philosophy is the same when going from S2 to S1 and the complete transition is shown in the timing diagram overleaf.

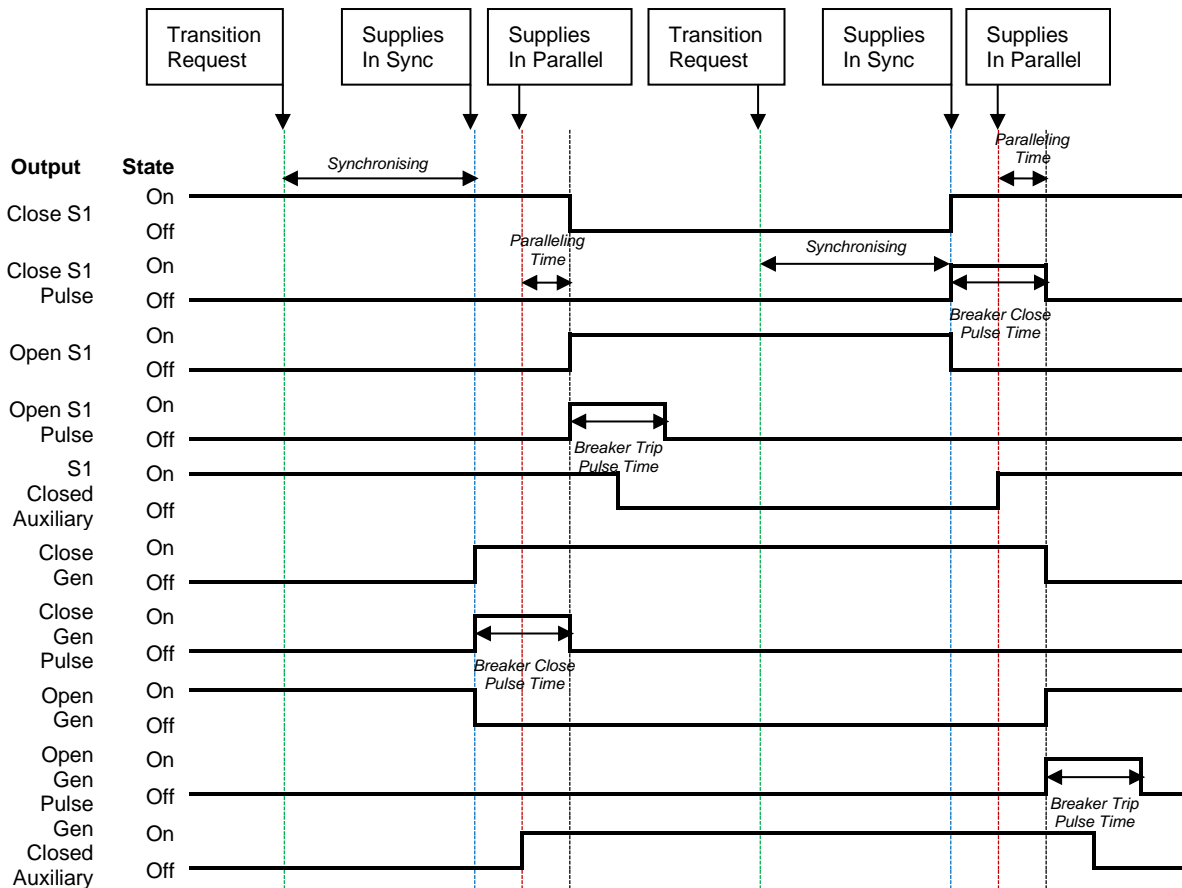

### 5.7.4 MANUAL LOAD SHED INPUT

When the *Load Shed* input is activated while S2 is closed the *Open S2* output energises, it then de-energises when the *S2 Closed Auxiliary* input indicates that it has successfully opened, or after 1s whichever occurs first.

When the *Load Shed* input is activated while S1 is closed the *Open S1* output energises, it then de-energises when the *S1 Closed Auxiliary* input indicates that it has successfully opened, or after 1s whichever occurs first.

When the *Load shed* input is de-energised the load is returned to the supply that was disconnected, providing that supply is healthy.

### 5.7.5 AUTOMATIC LOAD SHEDDING CONTROL

The *Load Shedding Control* feature (if enabled) allows for a maximum of five load shedding steps. When S2 is selected as a generator source and is about to take load, the configured number of *Load Shedding Control Outputs at Start* are energised. This allows certain none-essential loads to be removed prior to the generator's load switch being closed. This is used to ensure the initial loading of the generator is kept to a minimum, below the *Load Acceptance* specification of the generator.

The generator is then placed on load. The *Load Shedding Control* scheme begins. When the generator loading exceeds the *Load Shedding Trip* level the *Trip Delay* timer starts. If the generator loading is still high when the timer expires, the first *Load shedding Control* output energises. When the generator loading been above the trip level for the duration of the timer the 'next' *Load Shedding Control* output energises and so on until all *Load Shedding Control* outputs are energised.

When the generator loading falls below the *Load Shedding Return* level, the *Return Delay Time* starts. If the generator load remains below the *Load Shedding Return* level when the timer has expired, the 'highest' *Load Shedding Control* output de-energises. This process continues until all outputs have been de-energised.

When the generator enters a stopping sequence for any reason, all the *Load Shedding Control* outputs de-energise at the same time as the generator load switch is signalled to open.

Example screen shot of *Load Shedding Control* setup in the DSE Configuration Suite:

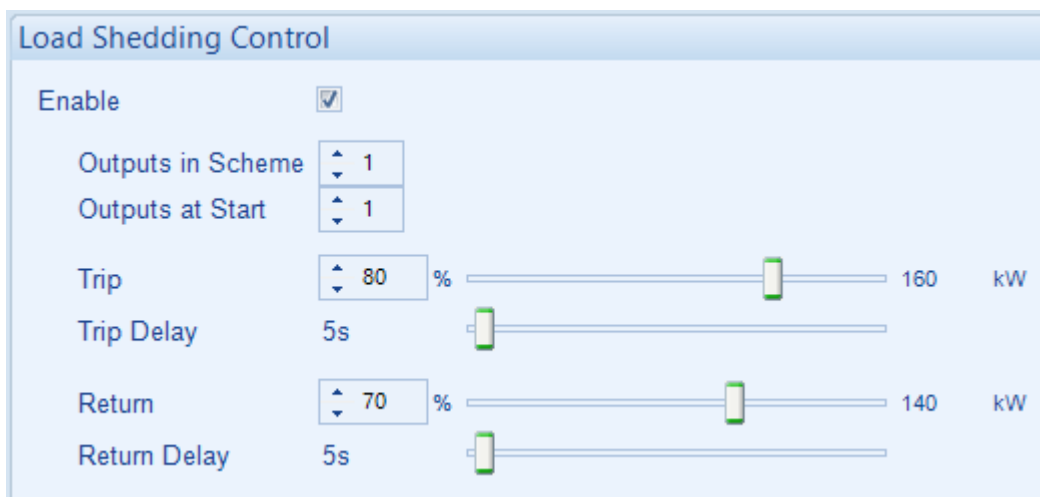

## 6 PROTECTIONS

### 6.1 ALARMS

When an alarm is active, the LCD display jumps from the 'Information page' to display the Alarm Page and the *Common Alarm* output if configured, activates.

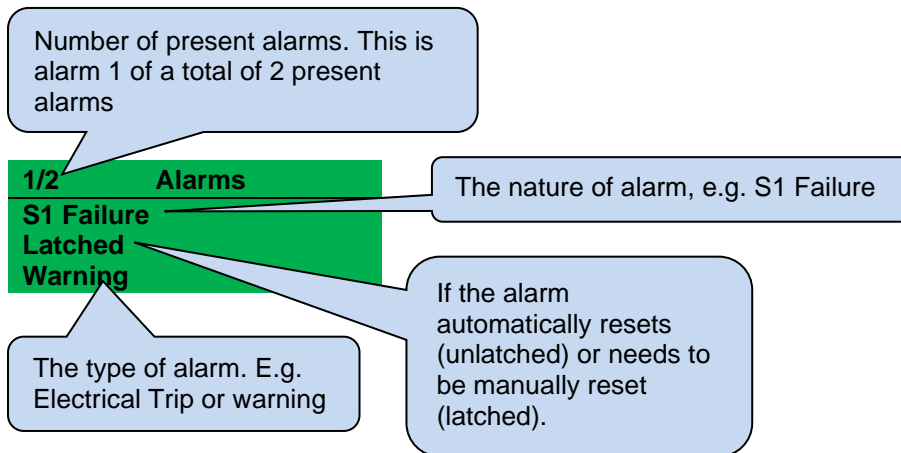

The LCD displays multiple alarms E.g. "S1 Failure Warning", "Fail to Stop Warning" and "Digital Input A Electrical Trip". These automatically scroll in the order that they occurred.

In the event of a warning alarm, the LCD displays the appropriate text. If an electrical trip then occurs, the module again displays the appropriate text.

Example:-

```

1/2    Alarms
-----
S1 Failed
Unlatched
Warning
    
```

```

2/2    Alarms
-----
S1 Failed to Close
Start Inhibit: Failed to Close
Warning
    
```

## 6.2 INDICATIONS

Indications are non-critical and often status conditions. They do not appear on the LCD display of the module as a text message in the *Status*, *Event Log* or *Alarms* pages. However, an output or LED indicator is configured to draw the operator's attention to the event.

### Example:

- Input configured for indication.
- The LCD text does not appear on the module display but may be added in the configuration to remind the system designer what the input is used for.
- As the input is configured to *Indication* there is no alarm generated.
- LED Indicator 1 illuminates when Digital Input A is active.
- The Insert Card Text allows the system designer to print an insert card detailing the LED function.
- Example showing operation of the LED.

Digital Input A

Function: User Configured

Polarity: Open to Activate

Action: Indication

Arming: Always

LCD Display: Panel Door Open

Activation Delay: 0s

LED Indicators

1	Digital Input A	Lit	Red
2	Not Used	Lit	Red
3	Not Used	Lit	Red
4	Not Used	Lit	Red

Insert Card Text: Digital input

Buttons: Text Insert, Logo Insert



### 6.3 WARNING ALARMS

Warnings are non-critical alarm conditions and do not affect the operation of the system, they serve to draw the operators attention to an undesirable condition.

Example

1/2	Alarm
S1 Failure	
Latched	
Warning	

In the event of an alarm the LCD jumps to the alarms page and scroll through all active warnings and alarms.

By default, warning alarms are self-resetting when the fault condition is removed. However, enabling *All Warnings Are Latched* causes warning alarms to latch until reset manually. This is enabled using the DSE Configuration Suite in conjunction with a compatible PC.

Fault	Description
2130 ID 1 to 4 Analogue Input E to H High	<p><b>▲ NOTE: Due to module configuration the alarm message that appears on the display may be different. For further details of module configuration, refer to DSE Publication: 057-367 DSE335 MKII Configuration Suite PC Software Manual.</b></p> <p>The module detected that an analogue input value of a DSE2130 had risen above the <i>Flexible Sensor High Pre-Alarm Trip</i> level.</p>
2130 ID 1 to 4 Analogue Input E to H Low	<p><b>▲ NOTE: Due to module configuration the alarm message that appears on the display may be different. For further details of module configuration, refer to DSE Publication: 057-367 DSE335 MKII Configuration Suite PC Software Manual.</b></p> <p>The module detected that an analogue input value of a DSE2130 had fallen below the <i>Flexible Sensor Low Pre-Alarm Trip</i> level.</p>
2130 ID1 to 4 Digital Input A to H	<p><b>▲ NOTE: Due to module configuration the alarm message that appears on the display may be different. For further details of module configuration, refer to DSE Publication: 057-367 DSE335 MKII Configuration Suite PC Software Manual.</b></p> <p>The module detected that a digital input configured to create a fault condition on a DSE2130 expansion module became active and the appropriate LCD message displayed.</p>
Battery Over Voltage IEEE 37.2 – 59 DC Overvoltage Relay	The DC supply has risen above the high volts setting level for the duration of the high battery volts timer
Battery Under Voltage IEEE 37.2 – 27 DC Undervoltage Relay	The DC supply has fallen below the low volts setting level for the duration of the low battery volts timer
Digital Input A To L	The module detected that a digital input configured to create a fault condition became active and the appropriate LCD message is displayed.

Continued over page...



Protections

Fault	Description
Fail To Start	S2 has not reached the configured limits or loading voltage and frequency before the S2 Fail Delay timer has expired.
Fail To Stop	The module has detected a condition that indicates that S2 is present when it has been instructed to stop.
Loading Frequency Not Reached	Indicates that the S2 frequency is not above the configured <i>loading frequency</i> . S2 does not take load when the alarm is present after the safety timer.  <b>▲NOTE: Only applicable when S2 is configured as a generator supply.</b>
Loading Voltage Not Reached	Indicates that the S2 voltage is not above the configured <i>loading voltage</i> . S2 does not take load when the alarm is present after the safety timer.  <b>▲NOTE: Only applicable when S2 is configured as a generator supply.</b>
PLC Functions 1 To 20	If a PLC Function has been configured as a warning the appropriate LCD message is displayed and the <b>COMMON ALARM LED</b> illuminates.
S1 Fail Latched	The module has detected that S1 has failed for an under/over voltage/frequency condition. The latched alarm is not automatically cleared and must be reset manually before S1 is returned to an available state.
S1 Failed To Close IEEE C37.2 – 52b AC Circuit Breaker Position (Contact Open when Breaker Closed)	The module detected that the generator load switch had failed to close as the <i>S1 Closed Auxiliary</i> input did not activate within the <i>Fail to Close Delay</i> time after the <i>Close Gen Output</i> activated.
S1 Failed To Open IEEE C37.2 – 52b AC Circuit Breaker Position (Contact Open when Breaker Closed)	The module detected that the generator load switch had failed to open as the <i>S1 Closed Auxiliary</i> input stayed activate for the <i>Fail to Open Delay</i> time after the <i>Open Gen Output</i> activated.
S2 Fail Latched	The module has detected that S2 has failed for an under/over voltage/frequency condition. The latched alarm is not automatically cleared and must be reset manually before S2 is returned to an available state.
S2 Failed To Close IEEE C37.2 – 52b AC Circuit Breaker Position (Contact Open when Breaker Closed)	The module detected that the generator load switch had failed to close as the <i>S2 Closed Auxiliary</i> input did not activate within the <i>Fail to Close Delay</i> time after the <i>Close Gen Output</i> activated.
S2 Failed To Open IEEE C37.2 – 52b AC Circuit Breaker Position (Contact Open when Breaker Closed)	The module detected that the generator load switch had failed to open as the <i>S2 Closed Auxiliary</i> input stayed activate for the <i>Fail to Open Delay</i> time after the <i>Open Gen Output</i> activated.

## 6.4 ELECTRICAL TRIP ALARMS

**▲ NOTE:** The fault condition must be resolved before the alarm is allowed to be reset. If the fault condition remains, it is not possible to reset the alarm (the exception to this is the *Coolant Temp High* alarm and similar *Active From Safety On* alarms, as the coolant temperature could be high with the engine at rest).

Electrical Trip Alarms are latching and unload S1 and S2 but in a controlled manner. On initiation of the electrical trip condition the module de-activates the **Close S1 Output and the Close S2 Output** to remove the load from the generator. Once this has occurred the module starts the *Cooling Timer* and allows the engine to cool off-load before shutting down the engine. To restart the generator the fault must be cleared, and the alarm reset.

Example

1/2	Alarms
Digital Input A	
Latched	
Electrical Trip	

In the event of an alarm the LCD jumps to the alarms page and scrolls through all active alarms.

Electrical Trip Alarms are latching alarms and to remove the fault, press the **Start Inhibit Mode**  button on the module.

Fault	Description
2130 ID 1 to 4 Analogue Input E to H High	<p><b>▲ NOTE:</b> Due to module configuration the alarm message that appears on the display may be different. For further details of module configuration, refer to DSE Publication: <i>057-367 DSE335 MKII Configuration Suite PC Software Manual</i>.</p> <p>The module detected that an analogue input value of a DSE2130 had risen above the <i>Flexible Sensor High Alarm Trip</i> level.</p>
2130 ID 1 to 4 Analogue Input E to H Low	<p><b>▲ NOTE:</b> Due to module configuration the alarm message that appears on the display may be different. For further details of module configuration, refer to DSE Publication: <i>057-367 DSE335 MKII Configuration Suite PC Software Manual</i>.</p> <p>The module detected that an analogue input value of a DSE2130 had fallen below the <i>Flexible Sensor Low Alarm Trip</i> level.</p>
2130 ID1 to 4 Digital Input A to H	<p><b>▲ NOTE:</b> Due to module configuration the alarm message that appears on the display may be different. For further details of module configuration, refer to DSE Publication: <i>057-367 DSE335 MKII Configuration Suite PC Software Manual</i>.</p> <p>The module detected that a digital input configured to create a fault condition on a DSE2130 expansion module became active and the appropriate LCD message displayed.</p>

Continued over page...

Protections

<b>Fault</b>	<b>Description</b>
Auxiliary Inputs	If an auxiliary input has been configured as an electrical trip, the appropriate LCD message is displayed and the <b>COMMON ALARM LED</b> illuminates.
Calibration Lost	The module has lost its calibration settings and must be sent back to DSE to be re-calibrated.
PLC Functions	If a PLC Function has been configured as an electrical trip, the appropriate LCD message is displayed and the <b>COMMON ALARM LED</b> illuminates.
S1 Phase Rotation	The module has detected a wrong phase sequence for S1.
S2 Phase Rotation	The module has detected a wrong phase sequence for S2.

## 7 FRONT PANEL CONFIGURATION

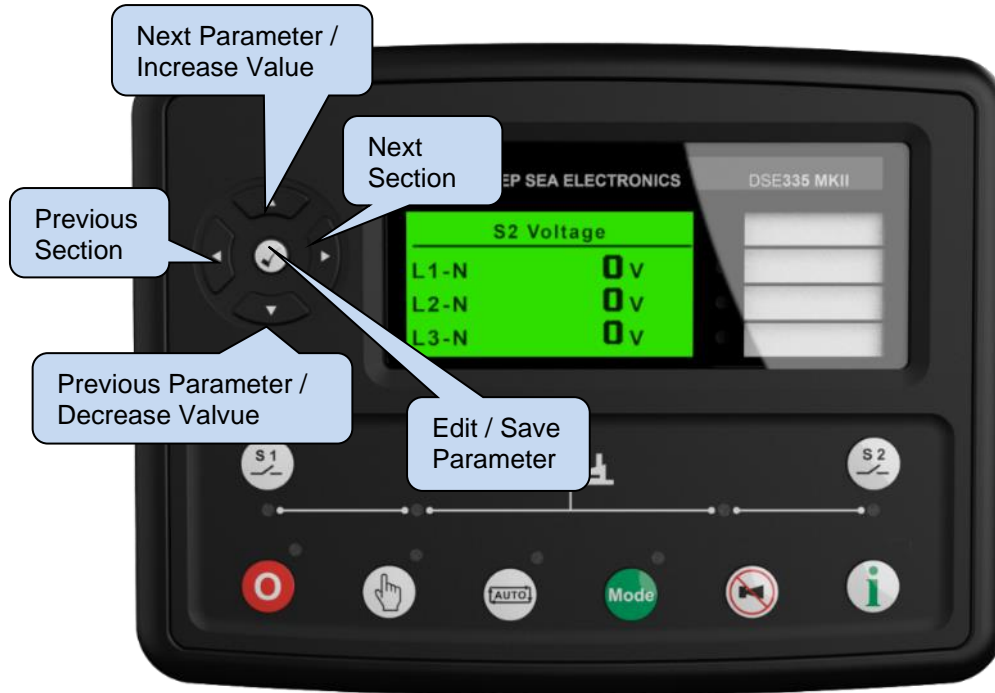

This configuration mode allows the operator to fully configure the module through its display without the use of the DSE Configuration Suite PC Software.

Use the module's facia buttons to traverse the menu and make value changes to the parameters:



## 7.1 ACCESSING THE FRONT PANEL EDITOR

 **NOTE:** Depending upon module configuration, some parameters in the Main Editor may not be available. For more information refer to DSE publication 057-367 DSE335 MKII Configuration Suite PC Software Manual available from [www.deepseaelectronics.com](http://www.deepseaelectronics.com)



- Ensure the engine is at rest and the module by pressing the **Start Inhibit Mode**  button.
- Press the **Start Inhibit Mode**  and **Tick**  buttons together to enter the main configuration editor.

### 7.1.1 ENTERING PIN

 **NOTE:** The PIN is not set by DSE when the module leaves the factory. If the module has a PIN code set, the generator supplier has entered this. Contact the generator supplier if the code is required. If the code has been 'lost' or 'forgotten', the module must be returned to the DSE factory to have the PIN removed. A charge is made for this procedure. This procedure cannot be performed away from the DSE factory.

 **NOTE:** The PIN is automatically reset when the editor is exited (manually or automatically) to ensure security.

- If a module security PIN has been set, the PIN request is then shown.

- Press the **Tick**  button, the first '#' changes to '0'. Press the **Up** or **Down**  buttons to adjust it to the correct value.

- Press the **Right**  button when the first digit is correctly entered. The digit previously entered now shows as '#' for security.

- Repeat this process for the other digits of the PIN number. Press the **Left**  button to move back to adjust one of the previous digits.

- When the **Tick**  button is pressed after editing the final PIN digit, the PIN is checked for validity. If the number is not correct, the PIN must be re-entered.

- If the PIN has been successfully entered (or the module PIN has not been enabled), the editor is displayed.



### 7.1.2 EDITING A PARAMETER

 **NOTE: The editor automatically exits after 5 minutes of inactivity to ensure security.**

 **NOTE: The PIN number is automatically reset when the editor is exited (manually or automatically) to ensure security.**

 **NOTE: For more information refer to DSE publication 057-367 DSE335 MKII Configuration Suite PC Software Manual.**

- Enter the editor as described above.

- Press the  (left) or  (right) buttons to cycle to the section to view/change.

- Press the  (up or down) buttons to select the parameter to view/change within the currently selected section.

- To edit the parameter, press the Tick  button to enter edit mode. The parameter begins to flash to indicate that value is being edited.

- Press the  (up or down) buttons to change the parameter to the required value.

- Press the Tick  button to save the value. The parameter ceases flashing to indicate that it has been saved.

### 7.1.3 EXITING THE MAIN CONFIGURATION EDITOR



 **NOTE: The editor automatically exits after 5 minutes of inactivity to ensure security.**

- Press and hold the **Start Inhibit Mode**  button to exit the editor without saving changes.

- Press and hold the **Tick**  button to exit the editor and save the changes.

7.1.4 MAIN CONFIGURATION EDITOR PARAMETERS

 **NOTE:** For more information refer to DSE publication 057-367 DSE335 MKII Configuration Suite PC Software Manual.

Section	Parameter As Shown On Display	Values
<b>Display</b>	Contrast	0 %
	Language	English
	LCD Page Delay	0 h 0 m 0 s
	LCD Scroll Delay	0 h 0 m 0 s
	Current Date And Time	DD:MM:YY, hh:mm:ss
<b>S1</b>	S1 Option	Generator, Mains
	Immediate S1 Dropout	Active / Inactive
	Under Voltage Trip	0 V
	Over Voltage Trip	0 V
	Under Frequency Trip	0.0 Hz
	Over Frequency Trip	0.0 Hz
<b>S2</b>	S2 Option	Generator, Mains
	Immediate S2 Dropout	Active / Inactive
	Under Voltage (Generator Option)	0 V
	Over Voltage (Generator Option)	0 V
	Under Frequency (Generator Option)	0.0 Hz
	Over Frequency (Generator Option)	0.0 Hz
<b>Timers</b>	S1 Transient Delay	0 m 0 s
	S2 Start Delay	0 h 0 m 0 s
	S2 Warming	0 h 0 m 0 s
	S2 Fail To Start Delay	0 m 0 s
	Elevator Delay	0 m 0 s
	Non-Sync Transfer Time	0 m 0 s
	Check-Sync Transfer Time	0 m 0 s
	S2 Return Delay	0 h 0 m 0 s
	S2 Cooling	0 h 0 m 0 s
	S2 Fail To Stop Delay	0 m 0 s
	S2 Transient Delay	0.0 s
	<b>Schedule</b>	Schedule
Schedule Bank 1 Period		Weekly / Monthly,
Do Not transfer, Off Load or Transfer, Week, Start Time, Run Time, and Day. Selection (1 to 8)		Press the Tick  button to begin editing then up or down when selecting the different parameters.
Schedule Bank 2 Period		Weekly / Monthly,
Do Not transfer, Off Load or Transfer, Week, Start Time, Run Time, and Day. Selection (1 to 8)		Press the Tick  button to begin editing then up or down when selecting the different parameters.

## 8 COMMISSIONING

Before the system is started, it is recommended that the following checks are made:-

1. The unit is adequately cooled and all the wiring to the module is of a standard and rating compatible with the system. Check all mechanical parts are fitted correctly and that all electrical connections (including earths) are sound.
2. The unit DC supply is fused and connected to the battery and that it is of the correct polarity.
3. To check the start cycle operation, take appropriate measures to prevent S2 from starting (if configured as a generator by disconnecting the start output) and press the *Manual*  mode button. Check to see if the start signal energises.
4. Set the modules internal clock/calendar to ensure correct operation of the scheduler and event logging functions.
5. Customers who are facing difficulties in obtaining desired operational results despite conducting multiple checks on the connections between the controller and their respective system are encouraged to contact DSE Technical Support for assistance.
6. Remove the remote start signal. The return sequence begins. After the pre-set time, the generator is unloaded. The generator then runs for the pre-set cooling down period, then shutdown into its standby mode.
7. Set the modules internal clock/calendar to ensure correct operation of the scheduler and event logging functions.



## 9 FAULT FINDING

### 9.1 STARTING

Symptom	Possible Remedy
Unit is inoperative	Check the battery and wiring to the unit. Check the DC supply. Check the DC fuse.
Read/Write configuration does not operate	
Unit shuts down	Check DC supply voltage is not above 35 Volts or below 9 Volts Check the operating temperature is not above 70 °C. Check the DC fuse.
Fail to Start is activated	Check wiring of the S2 sensing cables. Check the start output is correctly wired into the generator controller.
Continuous starting of S2 when in <b>Auto Mode</b> 	Check that there is no signal present on the "Remote Start" input. Check configured polarity is correct. Check the S2 supply available and within configured limits
S2 fails to start or go on load on receipt of Remote Start signal.	Check S2 Fail Delay timer has timed out.  Check signal is on "Remote Start" input. Confirm correct configuration of input is configured to be used as "Remote Start".

### 9.2 LOADING

Symptom	Possible Remedy
S2 supply present runs but does not take load	Ensure S2 is available and within configured limits and a load inhibit signal is not present on the module inputs. Check connections to the switching device.  Note that S2 does not take load in <b>Manual Mode</b>  unless there is an active remote start on load signal.

### 9.3 ALARMS

Symptom	Possible Remedy
Electrical Trip fault operates	Check relevant switch and wiring of fault indicated on LCD display. Check configuration of input.
Warning fault operates	Check relevant switch and wiring of fault indicated on LCD display. Check configuration of input.

### 9.4 COMMUNICATIONS

Symptom	Possible Remedy
RS485 inoperative	Check : <ul style="list-style-type: none"> <li>• Connection cable – Belden 9841 or equivalent</li> <li>• 120 Ω termination resistors are correctly fitted</li> <li>• Baud rate of controller and of client device are the same</li> <li>• Server ID of the controller is the same as configured in the client device</li> </ul>
DSENet	Check : <ul style="list-style-type: none"> <li>• Connection cable – Belden 9841 or equivalent</li> <li>• 120 Ω termination resistors are correctly fitted</li> <li>• DSENet ID on the expansion module is correct.</li> </ul>

## 9.5 INSTRUMENTS

Symptom	Possible Remedy
Inaccurate S1 & S2 measurements on controller display	<p>Check that the CT primary, CT secondary and VT ratio settings are correct for the application.</p> <p>Check that the CTs are wired correctly with regards to the direction of current flow (p1,p2 and s1,s2) and additionally ensure that CTs are connected to the correct phase (errors occur if CT1 is connected to phase 2).</p> <p>Remember to consider the power factor. i.e. (kW = kV A x powerfactor)</p> <p>The controller is true RMS measuring so gives more accurate display when compared with an 'averaging' meter such as an analogue panel meter or some lower specified digital multimeter.</p> <p>Accuracy of the controller is better than 1% of full scale. i.e. S1 volts full scale is 333 V ph-n so accuracy is <math>\pm 3.33</math> V (1% of 333 V).</p>

## 9.6 MISCELLANEOUS

 **NOTE:** The above fault finding is provided as a guide check-list only. As the module can be configured to provide a wide range of different features, always refer to the source of the module configuration if in doubt.

Symptom	Possible Remedy
Module appears to 'revert' to an earlier configuration	<p>When editing a configuration using the PC software it is vital that the configuration is first 'read' from the controller before editing it. This edited configuration must then be "written" back to the controller for the changes to take effect.</p> <p>When editing a configuration using the fascia editor, be sure to press the <b>Tick</b>  button to save the change before moving to another item or exiting the fascia editor</p>

## 10 MAINTENANCE, SPARES, REPAIR AND SERVICING

The controller is *Fit and Forget*. As such, there are no user serviceable parts within the controller. In the case of malfunction, contact the original equipment manufacturer (OEM).





### 10.1 PURCHASING ADDITIONAL CONNECTOR PLUGS FROM DSE

If additional plugs are required from DSE, please contact our sales department using the part numbers below.

#### 10.1.1 PACK OF PLUGS

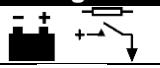
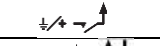
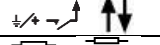
Module type	Plug Pack Part Number
DSE335 MKII	007-827

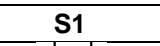
#### 10.1.2 INDIVIDUAL PLUGS

Module Terminal Designation	Plug Description	Part No.
1 to 8 	8 way 5.08 mm	007-164
9 to 17 	9 way 5.08 mm	007-167
18 to 24 	7 way 5.08 mm	007-447
25 to 29 	5 way 7.62 mm	007-473
30 to 37 	8 way 7.62 mm	007-454
38 to 41 <b>S1</b>	4 way 7.62 mm	007-171
42 to 47 	6 way 5.08 mm	007-446
48 to 53 	6 way 7.62 mm	007-162
54 to 56 <b>RS485</b>	3 way 5.08 mm	007-174
	PC Configuration interface lead (USB type A to USB type B)	

### 10.2 PURCHASING ADDITIONAL FIXING CLIPS FROM DSE

Item	Description	Part No.
	Module fixing clips (packet of 4)	020-294



### 10.3 PURCHASING ADDITIONAL SEALING GASKET FROM DSE

Item	Description	Part No.
	Module silicon sealing gasket	020-564

## 10.4 DSENET EXPANSION MODULES

**NOTE:** A maximum of six (6) expansion modules can be connected to the DSENet®.

**NOTE:** DSENet® utilises an RS485 connection. Using Belden 9841 (or equivalent) cable allows for the expansion cable to be extended to a maximum of 1.2 km. DSE Stock and supply Belden 9841 cable. DSE Part Number 016-030.

Item	Max No. supported	Description	Model order number	DSE Part Numbers		
				Sales literature	Operator manual	Installation Instructions
	2	Model DSE2130 input module provides additional analogue and digital inputs for use with the controller.	2130-001-00	055-060	057-082	053-033
	2	Model DSE2157 expansion relay module provides eight additional voltage free relays for use with the controller	2157-001-00	055-061	057-083	053-034
	2	Model DSE2548 expansion LED module provides additional LED indications, internal sounder, and remote lamp test/alarm mute for use with the controller.	2548-001-00	055-062	057-084	053-032

## 11 WARRANTY

DSE provides limited warranty to the equipment purchaser at the point of sale. For full details of any applicable warranty, refer to the original equipment supplier (OEM).

## 12 DISPOSAL

### 12.1 WEEE (WASTE ELECTRICAL AND ELECTRONIC EQUIPMENT)

If you use electrical and electronic equipment you must store, collect, treat, recycle, and dispose of WEEE separately from your other waste.



*This Page is Intentionally Blank*

*This Page is Intentionally Blank*